

BAZETTA TOWNSHIP TRUSTEES

REGULAR MEETING MINUTES

Date: September 08, 2020 @ 7:00 pm
Bazetta Township Administration Building
3372 State Route 5, N.E.
Cortland, Ohio 44410

Present:

Chairman Trustee Ted Webb - H
Vice Chairman Trustee Frank Parke - H
Trustee Bob McBride - H
Fiscal Officer Cynthia Chapman - A

Trustee Webb stated this meeting is being conducted via teleconference following the current guidelines defined by State of Ohio Open Meetings Law and in accordance under recommendations of legal counsel and Governor DeWine. There will be no public comments at the end of this meeting. This meeting is being audio recorded for informational purposes and will be posted on the website.

152-20 Resolution accepting the meeting minutes from the August 11th regular meeting, August 18th and August 26th Special Meetings.

Motion: Trustee P

Second: Trustee M

Vote: Trustee McBride Y Trustee Parke Y Trustee Webb Y

CORRESPONDENCE (COPIES AVAILABLE UPON REQUEST):

ADMINISTRATION:

153-20 Resolution authorizing the Fiscal Officer to pay all outstanding invoices and to approve all warrants incurred from September 09th thru October 13th.

Motion: Trustee M

Second: Trustee P

Vote: Trustee McBride Y Trustee Parke Y Trustee Webb Y

154-20 Resolution to set Trick or Treat for October _____ from _____pm.

Resolution to table until the next meeting.

Motion: Trustee P

Second Trustee M

Vote: Trustee McBride Y Trustee Parke Y Trustee Webb Y

155-20 Resolution to approve the attached Resolution "Accepting the Amount and Rates as Determined by the Budget Commission and Authorizing the Necessary Tax Levies and Certifying them to the County Auditor." (Fiscal Officer to supply the document)

Motion: Trustee M

Second Trustee P

Vote: Trustee McBride Y Trustee Parke Y Trustee Webb Y

156-20 Resolution to authorize the Fiscal Officer to make the following transfer.

\$1,500.00 from 1000-910-910-0000 (General: Transfers) to 1000-110-312-0000
(General: Auditing Services)

Motion: Trustee P

Second Trustee M

Vote: Trustee McBride Y Trustee Parke Y Trustee Webb Y

157-20 Resolution to approve an expenditure of CARES Act money not to exceed \$2,000 from StandUpStations.com for 15 Touch-less Hand Sanitizer Stations and 5 gallons of hand Sanitizer for Administration Building, Road Department, Police Department and the Fire Department .

Motion: Trustee M

Second Trustee P

Vote: Trustee McBride Y Trustee Parke Y Trustee Webb Y

FIRE DEPARTMENT:

- August monthly report is attached

158-20 Resolution to approve an expenditure of \$685.65 to Traffic Cones for Less.

- a. The More Grant of \$500 was obtained in February 2020. Total cost to taxpayers is \$185.65 and that total will be split between the police and fire department for \$92.83 each. (Quotes attached)

Motion: Trustee P

Second Trustee M

Vote: Trustee McBride Y Trustee Parke Y Trustee Webb Y

159-20 Resolution to approve a 1 year service contract at \$5,833.94 with Stryker Medical, P.O. Box 93308 Chicago, IL 60673-3308.

- a. This contract is for 2 cardiac monitors and 2 automatic CPR devices. (Contract attached)

Motion: Trustee M

Second Trustee P

Vote: Trustee McBride Y Trustee Parke Y Trustee Webb Y

160-20 Resolution to approve the purchase of Hydraulic Extrication Tools from Finley Fire Equipment for \$35,050.00. This purchase is being made through the Assistance to Firefighters Grant which \$32,380.95 (95%) is covered by grant and only \$1,669.05 of local tax payer dollars is being used.

a. 4 quotes are attached for review.

Motion: Trustee P

Second Trustee M

Vote: Trustee McBride Y Trustee Parke Y Trustee Webb Y

161-20 Resolution to hire Christopher Shafer Jr. as a part-time Firefighter/EMT, on an as needed basis with a probationary period of one year at a rate of \$11.00 per hour, pending physical, background investigations and pre-employment drug screen.

Motion: Trustee M

Second Trustee P

Vote: Trustee McBride Y Trustee Parke Y Trustee Webb Y

POLICE DEPARTMENT:

- August monthly report is attached

162-20 Resolution to accept quote 00038566 from Lexipol (Police One Academy) for a year of online training for the department in the amount of \$1,241.25. The training supplements our Lexipol policy manual, and will apply towards our CE Requirements. Training to be paid from Equipment Fund 2082-210-420-0000. (Quote attached)

Motion: Trustee P

Second Trustee M

Vote: Trustee McBride Y Trustee Parke Y Trustee Webb Y

163-20 Resolution to consider quote from JED Services for a new camera system for the police department building in the amount of \$5,353.00. This is needed as an improvement to communication with the public while the building is still closed to the public during this pandemic. This will also increase the safety of the staff and public. The quote is to be paid from CARES Act money received by the township. (Quote attached)

Resolution to table until the next meeting.

Motion: Trustee M

Second Trustee P

Vote: Trustee McBride Y Trustee Parke Y Trustee Webb Y

ROAD DEPARTMENT:

- The chapel is finished except for the carpet

164-20 Resolution to give permission for Road Superintendent Parke to apply for 2021 Issue 1 funding for TH155 Wilshire Drive/Ivy Hill Lane Drainage and Resurfacing Phase 1. The grant portion will be 54%, local share will be 23% loan and 23% for a total of 46% to be paid from the General Fund if project is awarded.

Fund if project is awarded.

Motion: Trustee M

Second Trustee P

Vote: Trustee McBride Y Trustee Parke Y Trustee Webb Y

165-20

Resolution to approve the purchase and installation of carpet for the cemetery chapel from Campbell Carpet in the amount of \$1,168.00 to be paid from the Cemetery Tornado Fund 2041-410-323-9000. (Quotes attached)

Motion: Trustee P

Second Trustee M

Vote: Trustee McBride Y Trustee Parke Y Trustee Webb Y

PLANNING DIRECTOR, ZONING INSPECTOR AND CODE ENFORCEMENT OFFICER:

- Monthly report is attached

ZONING COMMISSION AND ZONING BOARD OF APPEALS:

- All meetings have been cancelled due to the Covid-19 until further notice

PARKS AND RECREATION BOARD:

- Park will be closed indefinitely until further notice

166-20

Resolution to cancel the September 22, 2020 meeting.

Motion: Trustee M

Second Trustee P

Vote: Trustee McBride Y Trustee Parke Y Trustee Webb Y

There was a discussion to set up a special meeting with department heads to go over the CARES Act money. Each department head is to compile a list to discuss at this meeting. Chief Lewis stated to think of capital improvements that can improve the community. He also noted that they would need numbers from the fiscal officer.

ASKED TO BE PLACED ON THE AGENDA:

PUBLIC COMMENT:

Trustees Webb opened the meeting for public comment.

- Cheryl Tennant stated she made a public document request on August 27th and has not received anything. Trustee Webb stated the fiscal officer will fulfill her request.
- Mike Hovis questioned when to expect in person meetings
Trustee Webb explained the process we must abide by. Can only open up to 10 people at this time.

Trustees agreed to call a Special Zoom Meeting with department heads for September 15th at 6:00pm to discuss the CARES Act money.

167-20 To adjourn the meeting at 7:55 pm.

Motion: Trustee M

Second Trustee P

Vote: Trustee McBride Y Trustee Parke Y Trustee Webb Y

Attested by:

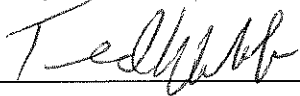

Approved by: Chairman Trustee Ted Webb

Date

Date

**RESOLUTION ACCEPTING THE AMOUNT AND RATES AS DETERMINED BY THE
BUDGET COMMISSION AND AUTHORIZING THE NECESSARY TAX LEVIES
AND CERTIFYING THEM TO THE COUNTY AUDITOR**

(BOARD OF TOWNSHIP TRUSTEES)

Revised Code, Secs. 5705.34-5705.35

The Board of Trustees of BAZETTA Township, TRUMBULL
County, Ohio, met in REGULAR session on the 2nd day of SEPTEMBER
20 21, at the office of BAZETTA TOWNSHIP ADMIN with the following members
present:

TRUSTEE ROBERT McBRIDE

TRUSTEE Ted Webb

TRUSTEE FRANK PARKER

TRUSTEE McBRIDE moved the adoption of the following Resolution:

RESOLVED, By the Board of Trustees of BAZETTA Township,
TRUMBULL County, Ohio, in accordance with the provisions of
Section 5705.281 R.C. , previously provided the Alternative Tax Budget Information for the next succeeding
fiscal year commencing January 1, 20 21;

and

WHEREAS, The Budget Commission of TRUMBULL County, Ohio, has
certified its action thereon to this Board together with an estimate by the County Auditor of the rate
of each tax necessary to be levied by this Board, and what part thereof is without, and what part
within the ten mill limitation; therefore, be it

RESOLVED, By the Board of Trustees of BAZETTA Township,
TRUMBULL County, Ohio, that the amounts and rates, as determined
by the Budget Commission in its certification, be and the same are hereby accepted; and be it further

RESOLVED, That there be and is hereby levied on the tax duplicate of said Township the rate
of each tax necessary to be levied within and without the ten mill limitation as follows:

FUND	Maximum Rate Authorized to be levied	County Auditor's Est. of Yield of Levy (Carry to Schedule A, Column II)
Special Levy Funds:		
Levy authorized by voters on Police Levy- Continous	05/07/13	1.00
Levy authorized by voters on Police Levy- Continous	05/07/13	1.00
Levy authorized by voters on Police Levy- Continous	05/07/13	0.50
Levy authorized by voters on Police Levy- Continous	05/08/84	1.00
Levy authorized by voters on Police Levy- Continous	05/08/90	1.50
Levy authorized by voters on Fire Levy- Continous	03/17/20	4.00
Levy authorized by voters on Fire & EMS Levy- not to exceed 5 years	11/07/17	1.50
Levy authorized by voters on Road & Bridge Levy - not to exceed 5 years	11/03/15	0.60
Levy authorized by voters on Fire Levy- not to exceed 5 years	03/15/16	0.80
Levy authorized by voters on Police Levy- not to exceed 5 years	03/15/16	0.60
Levy authorized by voters on Police Levy- not to exceed 5 years	11/03/15	1.80
Levy authorized by voters on Fire Levy- not to exceed 5 years	11/07/17	2.00

and be it further

RESOLVED, That the Clerk of this Board be and he is hereby directed to certify a copy of this Resolution to the County Auditor of Said County.

TRUSTEE PARKE seconded the Resolution and the roll being called upon its adoption the vote resulted as follows:

TRUSTEE Robert McBride,
TRUSTEE Ted Webb,
TRUSTEE FRANK PARKE -

Adopted the 8th day of September, 2020

Fiscal Officer of the Board of Township Trustees of
BAZETTA Township
TRUMBULL County, Ohio

BAZETTA

Incident Type Report (Summary)

Alarm Date Between {08/01/2020} And {08/31/2020}

Incident Type	Count	Pct of Incidents	Total Est Loss	Pct of Losses
1 Fire				
111 Building fire	3	2.80%	\$0	0.00%
	<u>3</u>	<u>2.80%</u>	<u>\$0</u>	<u>0.00%</u>
3 Rescue & Emergency Medical Service Incident				
311 Medical assist, assist EMS crew	2	1.86%	\$0	0.00%
321 EMS call, excluding vehicle accident with	76	71.02%	\$0	0.00%
322 Motor vehicle accident with injuries	3	2.80%	\$0	0.00%
324 Motor Vehicle Accident with no injuries	4	3.73%	\$0	0.00%
	<u>85</u>	<u>79.43%</u>	<u>\$0</u>	<u>0.00%</u>
4 Hazardous Condition (No Fire)				
412 Gas leak (natural gas or LPG)	1	0.93%	\$0	0.00%
424 Carbon monoxide incident	1	0.93%	\$0	0.00%
444 Power line down	1	0.93%	\$0	0.00%
	<u>3</u>	<u>2.80%</u>	<u>\$0</u>	<u>0.00%</u>
5 Service Call				
551 Assist police or other governmental agency	1	0.93%	\$0	0.00%
554 Assist invalid	2	1.86%	\$0	0.00%
561 Unauthorized burning	2	1.86%	\$0	0.00%
	<u>5</u>	<u>4.67%</u>	<u>\$0</u>	<u>0.00%</u>
6 Good Intent Call				
611E Dispatched & cancelled en route (EMS /	2	1.86%	\$0	0.00%
611F Dispatched & cancelled en route (Fire /	1	0.93%	\$0	0.00%
622 No Incident found on arrival at dispatch	3	2.80%	\$0	0.00%
	<u>6</u>	<u>5.60%</u>	<u>\$0</u>	<u>0.00%</u>
7 False Alarm & False Call				
731 Sprinkler activation due to malfunction	1	0.93%	\$0	0.00%
736 CO detector activation due to malfunction	2	1.86%	\$0	0.00%
745 Alarm system activation, no fire -	1	0.93%	\$0	0.00%
	<u>4</u>	<u>3.73%</u>	<u>\$0</u>	<u>0.00%</u>
8 Severe Weather & Natural Disaster				

BAZETTA

Incident Type Report (Summary)

Alarm Date Between {08/01/2020} And {08/31/2020}

Incident Type	Count	Pct of Incidents	Total Est Loss	Pct of Losses
8 Severe Weather & Natural Disaster				
813 Wind storm, tornado/hurricane assessment	1	0.93%	\$0	0.00%
	1	0.93%	\$0	0.00%

Total Incident Count: 107

Total Est Loss: \$0

BAZETTA

Aid Responses by Department

Alarm Date Between {08/01/2020} And {08/31/2020}

Incident	Notified	Type of Aid		Fire	EMS	Resc	Other
STA. 12 CORTLAND FIRE DEPARTMENT FDID 78200							
20-0000744	08/08/2020	4 Automatic aid given	#Personnel	0	2	0	0
Their Inci	1056	Response Time: 00:10:19	#Appartus	0	1	0	0
20-0000798	08/22/2020	3 Mutual aid given	#Personnel	0	3	0	1
Their Inci	1136	Response Time: 00:06:23	#Appartus	0	1	0	1
20-0000804	08/25/2020	1 Mutual aid received	#Personnel	0	2	0	0
Their Inci	1143	Response Time: 00:03:32	#Appartus	0	1	0	0
20-0000815	08/30/2020	4 Automatic aid given	#Personnel	4	0	0	0
Their Inci	2000812	Response Time: 00:05:51	#Appartus	1	0	0	0
20-0000816	08/30/2020	4 Automatic aid given	#Personnel	4	0	0	0
Their Inci	2000814	Response Time: 00:06:00	#Appartus	1	0	0	0
Subtotal Responses: 5			Average Response Time for Dept: 00:06:25				
STA. 21 CHAMPION FIRE DEPARTMENT FDID 78109							
20-0000779	08/18/2020	1 Mutual aid received	#Personnel	0	0	0	0
Their Inci	2020-21-01	Response Time: 00:08:02	#Appartus	0	0	0	0
20-0000817	08/31/2020	3 Mutual aid given	#Personnel	0	3	0	0
Their Inci	2001143	Response Time: 00:12:56	#Appartus	0	1	0	0
Subtotal Responses: 2			Average Response Time for Dept: 00:10:29				
STA. 30 HOWLAND FDID 78121							
20-0000794	08/21/2020	4 Automatic aid given	#Personnel	3	0	0	0
Their Inci	2002669	Response Time: 00:13:13	#Appartus	1	0	0	0
Subtotal Responses: 1			Average Response Time for Dept: 00:13:13				
STA. 32 HOWLAND FDID 78121							
20-0000718	08/01/2020	1 Mutual aid received	#Personnel	0	2	0	0
Their Inci	2034	Response Time: 00:05:55	#Appartus	0	1	0	0
20-0000755	08/12/2020	1 Mutual aid received	#Personnel	0	2	0	0
Their Inci	20-2130	Response Time: 00:04:44	#Appartus	0	1	0	0
Subtotal Responses: 2			Average Response Time for Dept: 00:05:20				

Response time calculated from time notified to arrival.

BAZETTA

Aid Responses by Department

Alarm Date Between {08/01/2020} And {08/31/2020}

Incident	Notified	Type of Aid		Fire	EMS	Resc	Other
STA. 38 MECCA FIRE DEPARTMENT FDID 78133							
20-0000736	08/06/2020	4 Automatic aid given	#Personnel	4	0	0	0
Their Inci	2000199	Response Time: 00:12:17	#Appartus	1	0	0	0
20-0000800	08/23/2020	1 Mutual aid received	#Personnel	0	0	0	5
Their Inci	214	Response Time: 00:09:51	#Appartus	0	0	0	1
Subtotal Responses: 2			Average Response Time for Dept: 00:11:04				

STA. 49 WARREN TWP. FIRE DEPT.

20-0000719	08/01/2020	3 Mutual aid given	#Personnel	0	2	0	1
Their Inci	0711	Response Time: 00:05:58	#Appartus	0	1	0	1
Subtotal Responses: 1			Average Response Time for Dept: 00:05:58				

Response time calculated from time notified to arrival.

Joint Bazetta PD/FD Safety Grant

To provide employees with additional equipment to safely assist the public during traffic control situations and active scenes.

After consulting with Fire Chief Lewis, we both are in agreement with the type and quantity of signs to purchase and put into service. This is being accomplished through a safety grant. The grant amount is \$500.00 (250.00 EA DEPT).

On all the apparatus of the FD, they have a total of 16 traffic cones. Chief Lewis requests that he purchase 16 arrow signs. One for each traffic cone.

After calculating the numbers of cones the PD has (52 Cones), Chief Herlinger is requesting 14 arrow signs. This allows 2/cruiser and two extra to be on station.

Chief Herlinger is also requesting 14 road closed signs. This also allows 2/cruiser with two extra to be on station.

All the signs are reflective and printed on one side only. I checked prices for the above items at 3 businesses on line. After consulting with Lewis, the best price for the quantities desired were from trafficconesforless.com.

The three businesses that we checked were:

TrafficSafety Store.com

Traffic Cones For Less.com

Safety Cones USA

Please find attached the descriptions and prices from all three.

30 Reversible Arrow Signs 14 Road Closed Signs

Traffic Safety Store 44 Signs \$ 979.00 plus s/h (37.85) (-500) 516085/2= 258.43 EA DEPT

Traffic Cones For Less 44 Signs \$ 638.00 plus s/h (47.65) (-500) 185.65/2= 92.83 EA DEPT

Safety Cones USA 44 Signs 44 Signs \$ 726 plus s/h (64.56) (-500)290.56 /2= 145.28 EA DEPT

TCFL Shipping: UPS Ground \$47.65 NO sales TAX-EXEMPT

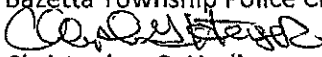
Bazetta Township Police Chief

Christopher G. Herlinger

Bazetta Township Fire Chief

Dennis K. Lewis

Traffic Safety Store

Reversible Arrow Clip-On Sign - Clip-On Signs for Traffic Cones

Rated 5/5 stars - Based on 13 reviews.

\$23.95
each
Quantity
1-14

\$22.25
each
Quantity
15-49

\$20.50
each
Quantity
50+

IN STOCK - SHIPS TOMORROW

Want a different legend? (</traffic-cones/signs-accessories#COSHREF>)

Want a custom sign? (</traffic-cones/cos-custom#COSHREF-B2O2-C1S>)

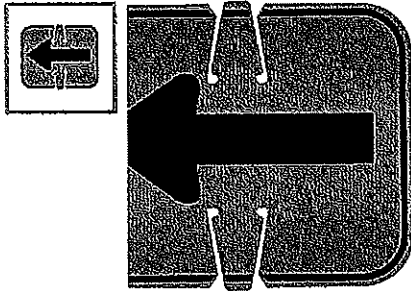

Description ^

This image of an arrow can be reversed to point either left or right, indicating to drivers or pedestrians which direction you want them to go.

- Horizontal (12 3/4" wide x 10 1/2" tall) clip on sign

Item # **REF-A100** Reversible Arrow Orange Finish

- Easy to install on any standard traffic cone or delineators
- Made from durable, sturdy, and weather resistant ABS plastic with UV inhibitors to prevent fading

Related Products ^

Road Closed Clip-On Sign - Clip-On Signs for Traffic Cones

Rated 5/5 ★★★★★ stars - Based on 13 reviews.

\$23.95

each

Quantity

1-14

\$22.25

each

Quantity

15-49

\$20.50

each

Quantity

50+

IN STOCK - SHIPS TOMORROW

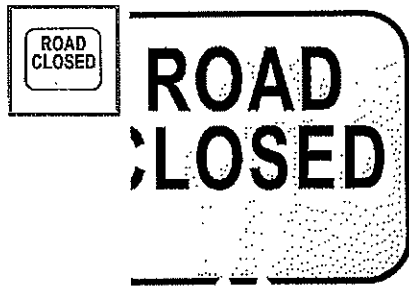

Want a different legend? (</traffic-cones/signs-accessories#COSHREF>)

Want a custom sign? (</traffic-cones/cos-custom#COSHREF-B202-C1S>)

Description ^

- Horizontal (12 3/4" wide x 10 1/2" tall) clip on sign
 - Reflective White Finish
 - Easy to install on any standard traffic cone or delineators
 - Made from durable, sturdy, and weather resistant ABS plastic with UV inhibitors to prevent fading
- Item #:COSHREF-RDCL

Related Products ^



[Traffic Cones For Less](#) / Payment Options

Payment Options

TrafficConesForLess.com makes it easy to do business with us. We accept all forms of payment including checks, credit cards (American Express, Visa and Mastercard) Purchase Orders, PayPal, EFT and Wire Transfers.

You can use most of these methods of payment in our shopping cart upon check out. For purchase orders, please contact us for a credit application. Our standard terms are net 10 days for purchase orders. For Wire Transfers, please contact us via email or phone for bank information.

TrafficConesForLess.com

Phone: 888-388-0180

Fax: 954-318-0440

Thank you for choosing Traffic Cones For Less!

Recent History

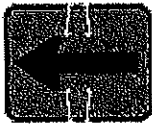

Traffic Cone Sign - REVERSIBLE

ARROW

\$12.40



Traffic Cone Sign - ROAD CLOSED

\$12.40

CONTACT US FOR EXPERT SUPPORT:

888-388-0180 or [Click to Chat](#)

Mon-Fri 9AM - 5PM EST

SIGN UP TO RECEIVE OUR SPECIALS:

Enter your email address

Submit

STAY CONNECTED



PAYMENT OPTIONS



SHOPPING WITH US

- My Account
- Pricing Information
- Order Process
- Return Policy
- Privacy Policy
- Legal Info
- Terms & Conditions
- Shipping

CUSTOMER TOOLS

- Traffic Cone Guide
- Stencils, Silkscreen & Full Color Logo
- Press Releases

TRAFFICCONESFORLESS.COM

- Contact Us
- About Traffic Cones For Less
- Our Clients
- Testimonials
- Site Map

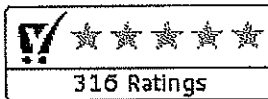

Call us at (toll free) [888-388-0180](tel:888-388-0180), Monday to Friday 9AM - 5PM EST

© 2013-2020 www.trafficconesforless.com. [Privacy Policy](#) | [Terms of Use](#)



Traffic Cones For Less / Your shopping cart

My Shopping Cart

[Secure Checkout](#)



Traffic Cone Sign - ROAD CLOSED

SKU: CS-W-08R

Size: 11" x 13" Print on both sides?: One Side Print Reflective: 3M Reflective (One Side)

[Edit options](#)

UNIT PRICE

\$14.50

14 [Update](#) [Remove](#)

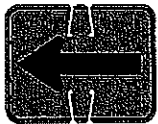

Traffic Cone Sign - REVERSIBLE ARROW

SKU: CS-O-06R

Size: 11" x 13" Print on both sides?: One Side Print Reflective: 3M Reflective (One Side)

[Edit options](#)

UNIT PRICE

\$14.50

30 [Update](#) [Remove](#)

Subtotal:

\$638.00

Shipping:

Not calculated

Sales Tax: (Tax in FL only)

\$0.00

Total:

\$638.00

Have a Coupon Code? Please submit it below

[Submit Coupon Code](#)

[Need a Quote?](#)

[Secure Checkout](#)

or use



CONTACT US FOR EXPERT SUPPORT:

888-388-0180 or [Click to Chat](#)
Mon-Fri 9AM - 5PM EST

SIGN UP TO RECEIVE OUR SPECIALS:

Enter your email address

Submit

STAY CONNECTED



PAYMENT OPTIONS



SHOPPING WITH US

- [My Account](#)
- [Pricing Information](#)
- [Order Process](#)
- [Return Policy](#)
- [Privacy Policy](#)
- [Legal Info](#)
- [Terms & Conditions](#)
- [Shipping](#)

CUSTOMER TOOLS

- [Traffic Cone Guide](#)
- [Stencils, Silkscreen & Full Color Logo](#)
- [Press Releases](#)

TRAFFICCONESFORLESS.COM

- [Contact Us](#)
- [About Traffic Cones For Less](#)
- [Our Clients](#)
- [Testimonials](#)
- [Site Map](#)



Call us at (toll free) [888-388-0180](tel:888-388-0180), Monday to Friday 9AM - 5PM EST
© 2013-2020 www.trafficconesforless.com. [Privacy Policy](#) | [Terms of Use](#)



Traffic Cone Sign - REVERSIBLE ARROW

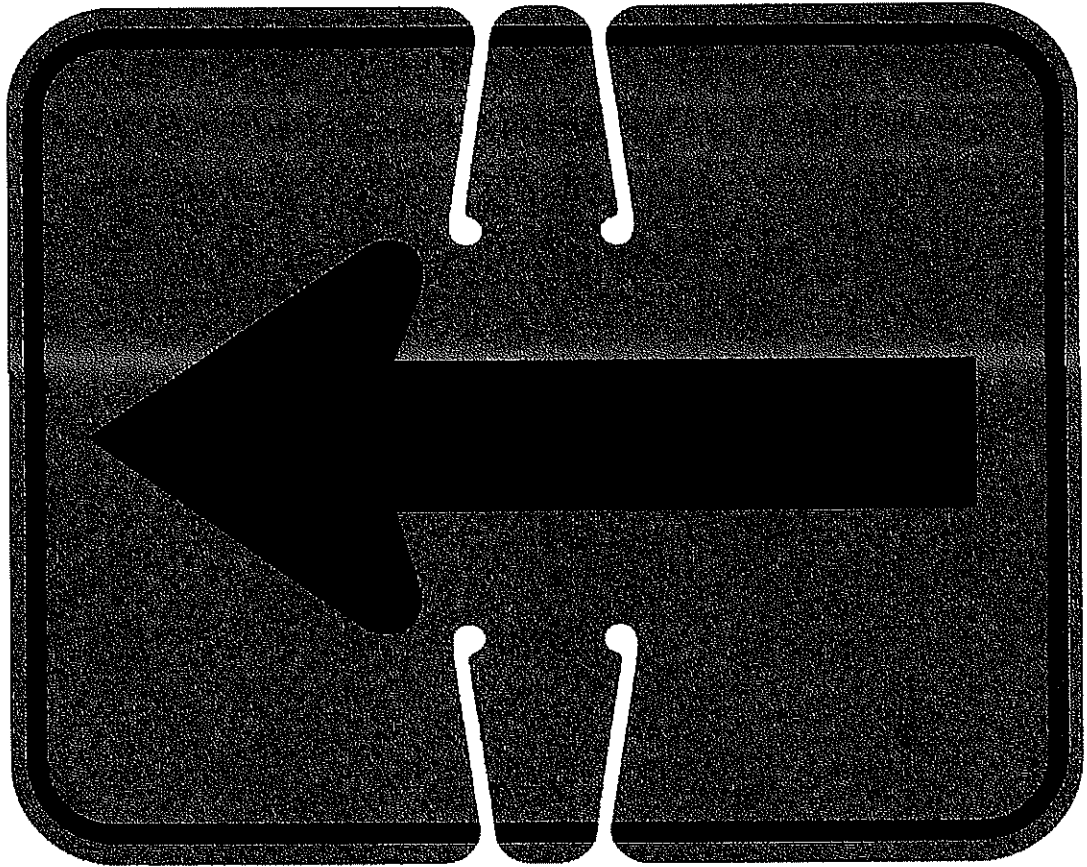

CS-0-06R ★ ★ ★ ★ ★

\$16.40 (~~\$19.68~~) 33% Off

Volume Pricing (quantity based)

1-9 Item

10-49 Items

50+ Items

\$16.40

\$14.50

\$13.45

Size

11" x 13"

Print on both sides?

One Side Print



Reflective

3M Reflective (One Side)



In Stock - Buy Now

1



Add to Cart

Customers Also Viewed



Universal Cone Adapter - Sign Holder
\$10.22

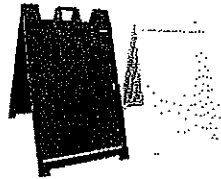

Signicade Deluxe Sidewalk Sign Frame
\$99.90

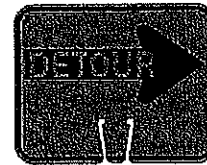

Traffic Cone Sign - DETOUR (Right)
\$12.40



Traffic Cone Sign - HANDICAP Symbol
\$12.40

Product Details



Specifications



Customer Feedback



Explore Related Products



Traffic Cone Sign - CUSTOM MESSAGE (White)

\$12.40



Traffic Cone Sign - CUSTOM MESSAGE (Orange)

\$12.40



Traffic Cone Sign - BLANK (White)

\$12.40



Traffic Cone Sign - NO PARKING

\$12.40



Traffic Cone Sign - HANDICAP Symbol

\$12.40



Traffic Cone Sign - CUSTOM MESSAGE (Green)

\$12.40

Recent History



Traffic Cone Sign - REVERSIBLE ARROW

\$12.40

CONTACT US FOR EXPERT SUPPORT:

888-388-0180 or [Click to Chat](#)

SIGN UP TO RECEIVE OUR SPECIALS:

Enter your email address

Submit

STAY CONNECTED



PAYMENT OPTIONS



SHOPPING WITH US

- My Account
- Pricing Information
- Order Process
- Return Policy
- Privacy Policy
- Legal Info
- Terms & Conditions
- Shipping

CUSTOMER TOOLS

- Traffic Cone Guide
- Stencils, Silkscreen & Full Color Logo
- Press Releases

TRAFFICCONESFORLESS.COM

- Contact Us
- About Traffic Cones For Less
- Our Clients
- Testimonials
- Site Map



Call us at (toll free) [888-388-0180](tel:888-388-0180), Monday to Friday 9AM - 5PM EST
 © 2013-2020 www.trafficconesforless.com. [Privacy Policy](#) | [Terms of Use](#)



Traffic Cone Sign - ROAD CLOSED



CS-W-08R ★ ★ ★ ★ ★

\$16.40 (~~\$19.68~~) 33% Off

Volume Pricing (quantity based)

1-9 Item

10-49 Items

50+ Items

\$16.40

\$14.50

\$13.45

Size

11" x 13"

Print on both sides?

One Side Print



Reflective

3M Reflective (One Side)



In Stock - Buy Now

1



Add to Cart

Customers Also Viewed

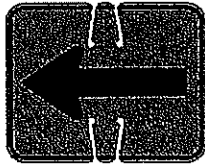

Traffic Cone Sign - REVERSIBLE ARROW

\$12.40



Universal Cone Adapter - Sign Holder

\$10.22

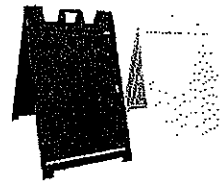

Signcade Deluxe Sidewalk Sign Frame

\$99.90



Traffic Cone Sign HANDICAP Symbol

\$12.40

Product Details



Specifications



Customer Feedback



Explore Related Products



Traffic Cone Sign - CUSTOM MESSAGE (White)

\$12.40



Traffic Cone Sign - CUSTOM MESSAGE (Orange)

\$12.40



Traffic Cone Sign - BLANK (White)

\$12.40



Traffic Cone Sign - REVERSIBLE ARROW

\$12.40



Traffic Cone Sign - NO PARKING

\$12.40



Traffic Cone Sign - HANDICAP Symbol

\$12.40

Recent History



Traffic Cone Sign - ROAD CLOSED

\$12.40



Traffic Cone Sign - REVERSIBLE ARROW

\$12.40

CONTACT US FOR EXPERT SUPPORT:

888-388-0180 or Click to Chat

SIGN UP TO RECEIVE OUR SPECIALS:

Enter your email address

Submit

STAY CONNECTED



PAYMENT OPTIONS



SHOPPING WITH US

- My Account
- Pricing Information
- Order Process
- Return Policy
- Privacy Policy
- Legal Info
- Terms & Conditions
- Shipping

CUSTOMER TOOLS

- Traffic Cone Guide
- Stencils, Silkscreen & Full Color Logo
- Press Releases

TRAFFICCONESFORLESS.COM

- Contact Us
- About Traffic Cones For Less
- Our Clients
- Testimonials
- Site Map

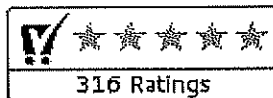

Call us at (toll free) 888-388-0180, Monday to Friday 9AM - 5PM EST

© 2013-2020 www.trafficconesforless.com, [Privacy Policy](#) | [Terms of Use](#)



SC Supply Company, LLC

SafetyConesUSA.com

PO Box 11531
 South Bend, IN 46634-0153
 800-640-1843

Quote

DATE	QUOTE #
8/19/2020	26079

Certified WBE

BILL TO NAME / ADDRESS	SHIP TO NAME / ADDRESS
Bazetta Township OH 44410	

Terms

Account #

P.O. NO.

QTY	ITEM	DESCRIPTION	PRICE	TOTAL
30	CS-O-06R-c	Reversible Arrow REFLECTIVE Cone Sign - Black on Orange-notch on top and bottom	16.50	495.00
14	CS-W-08R-c	ROAD CLOSED REFLECTIVE Cone Sign - Black on White	16.50	231.00
	SC/UPS-C	UPS GROUND	64.56	64.56
		Commercial Delivery -		
		Sales Tax Information Needed	0.00%	0.00

**Due to fluctuating Aluminum and Steel prices, any quotes for Aluminum Signs or Steel Posts are only good for the week the quote is given in. We apologize for any inconvenience as this is beyond our control.

TOTAL USD	\$790.56
------------------	----------

Phone #	Fax #
800-640-1843	574-234-5066

SIGNATURE _____

Custom orders are Non-Returnable. Product quotes are good for 30 days(please see above disclaimer). Shipping quotes are good for 14 days and then are subject to change. These products and more can be veiwed on our web site at www.SafetyConesUSA.com.**



SAFETY CONES USA

SC Supply Company, LLC

Toll Free
1-800-640-1843
Local - 1-574-287-0252
Fax - 1-574-234-5066
Hours 7:30 to 5:30 EST

Your source for traffic safety cones, traffic safety signs, traffic barricades, reflective apparel & so much more! [HOME](#) [ABOUT US](#) [POLICIES](#) [CONTACT](#)

Categories



Traffic Cone Signs

Home

Airport Safety

Traffic Cone Signs can be used on delineators, traffic cones and traffic barrels. They are used to further enhance the safety of a work site and protect pedestrians and workers alike.

Aluminum Signs

Safety Cones USA carries standard legends, sign blanks or you can create your own custom sign. Sign blanks come in ORANGE, WHITE, YELLOW, BLUE, GREEN and RED. Our cone signs measure 13.25"W x 11"H and are constructed from UV Stabilized PVC plastic.

Barrels - Drums

Barricades

Orders that fall under \$150.00 are subject to a \$15.00 under minimum fee.

Barricade Lights

Bollard Covers

Give us a call at 800-640-1843 or [Email](#) for a quote!

<u>NON-REFLECTIVE</u>		<u>REFLECTIVE</u>	
1-5	\$14.95	1-5	\$18.95
6-15	\$13.20	6-15	\$17.90
16-49	\$11.95	16-49	\$16.97
50+	\$10.90	50+	\$16.03

Bollard - Flexible

Item Numbers are located beneath each sign
For Reflective Signs, Just ADD a R to the end of the Item Number
 (Reflective Signs are considered custom and are non-returnable)

Channelizers

Custom Sign Legends:
Set-Up Charge of \$40.00 plus cost of sign

Traffic Cones

Cone Accessories

Cone Signs

Delineators

Flags - Pennants

Flexstake

Hard Hats & Caps

Ladder Safety

Pavement Markers

Rock-It Sign Stand

Roll Up Signs

Safety Apparel

Safety Vests

Sign Stands

Speed Bumps

Stop/Slow Paddles

Valet/Parking Panels

Vertical Panels

Worker Safety

Work Area Lighting

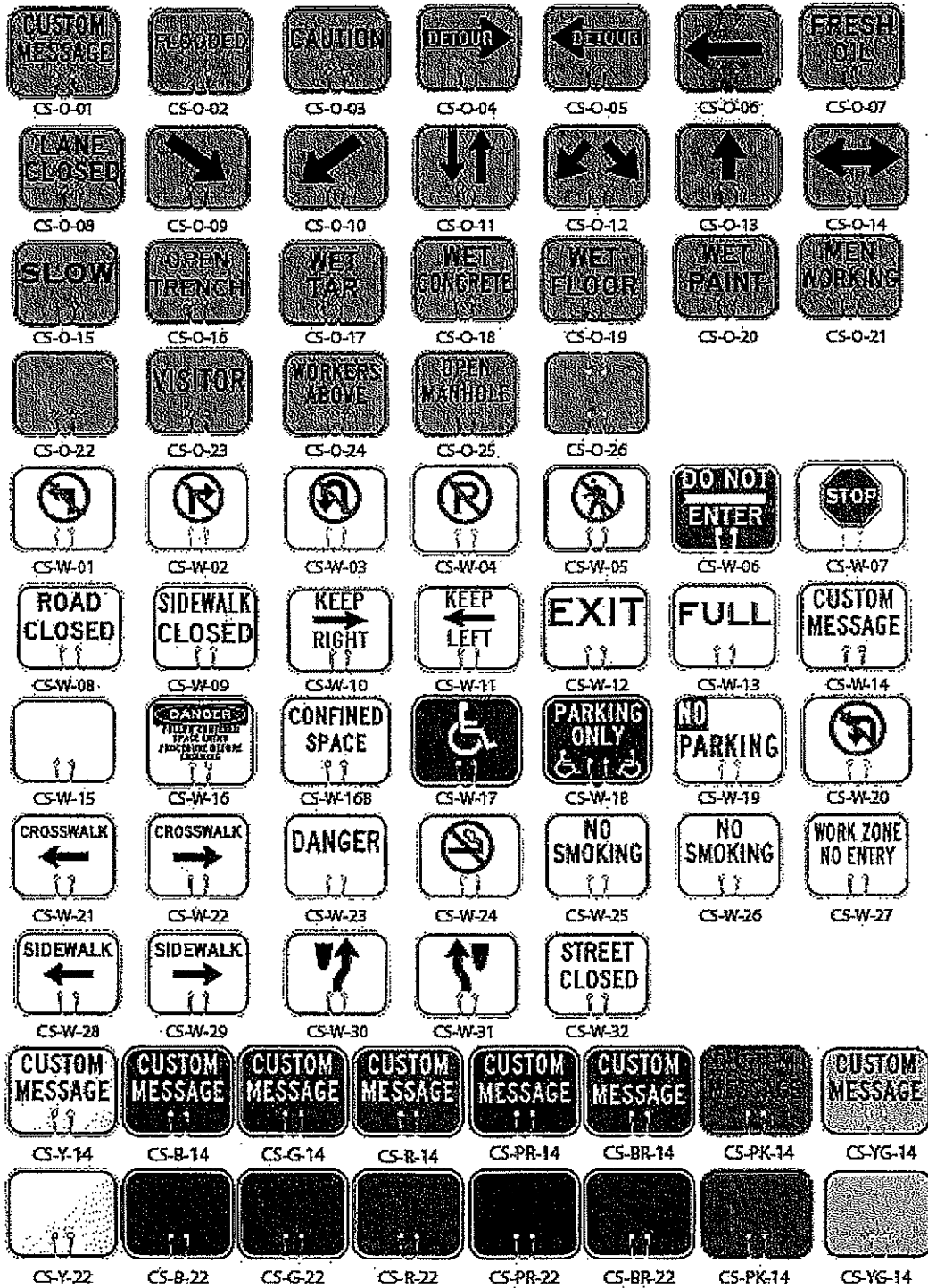





New Service Plan Effective 9/1/20 to 8/31/23

Quote Number: 10241702

Remit to: **Stryker Medical**

Version: 1

P.O. Box 93308

Chicago, IL 60673-3308

Prepared For: BAZETTA FIRE DEPT

Rep: Phil Howard

Attn: Brad Hall

Email: phil.howard@stryker.com

bhall@bazettatwp.org

Phone Number: (888) 627-9698 x 78235

(330) 442-1212

Quote Date: 08/24/2020

Delivery Address

End User - Shipping - Billing

Bill To Account

Name: BAZETTA FIRE DEPT

Name: BAZETTA FIRE DEPT

Name: BAZETTA FIRE DEPT

Account #: 1074208

Account #: 1074208

Account #: 1074208

Address: 3000 WARREN MEADVILLE RD

Address: 3000 WARREN MEADVILLE RD

Address: 3000 WARREN MEADVILLE RD

CORTLAND

CORTLAND

CORTLAND

Ohio 44410-9322

Ohio 44410-9322

Ohio 44410-9322

ProCare Products:

Product	Description	Qty	Start Date	End Date	Sell Price	Total
78000008	LP15 On Site Prevent w batt	2	09/01/2020	08/31/2021	\$1,710.00	\$3,420.00
78000020	LUC On Site Prevent w batt	1	09/01/2020	08/31/2021	\$1,193.40	\$1,193.40
78000020	LUC On Site Prevent w batt	1	10/30/2020	10/29/2021	\$1,220.54	\$1,220.54
ProCare Total:						\$5,833.94

Price Totals:

Grand Total: \$5,833.94

Comments:

Term: 1-Year
Billing Annually
Effective: 9/1/20 to 8/31/21
Devices:
2-ea. LIFEPAK 15 v2 w/ On-Site Prevent w/
Batteries
S/N: 40356238 40360472
1-ea. LUCAS w/ On-Site Prevent w/ Batteries
& 15% POS Discount
S/N: 3016G718
1-ea. LUCAS w/ On-Site Prevent w/ Batteries
(PORATED FOR 334 DAYS -- EFFECTIVE
10/1/20 to 8/31/21)
S/N: 3519G292

Prices: In effect for 60 days.



**New Service Plan Effective 9/1/20 to
8/31/23**

Quote Number: 10241702

Remit to: **Stryker Medical**

Version: 1

P.O. Box 93308

Chicago, IL 60673-3308

Prepared For: BAZETTA FIRE DEPT

Rep: Phil Howard

Attn: Brad Hall

Email: phil.howard@stryker.com

bhall@bazettatwp.org

Phone Number: (888) 627-9698 x 78235

(330) 442-1212

Quote Date: 08/24/2020

Terms: Net 30 Days

Ask your Stryker Sales Rep about our flexible financing options.

The Terms and Conditions of this quote and any subsequent purchase order of the Customer are governed by the Terms and Conditions located at <https://techweb.stryker.com>. The terms and conditions referenced in the immediately preceding sentence do not apply where Customer and Stryker are parties to a Master Service Agreement.

AUTHORIZED CUSTOMER SIGNATURE

LIFEPAK® 15 service

Stryker has been notified by our global parts providers that some components used on certain LIFEPAK 15 monitor/defibrillator models (Part Numbers beginning with V15-2) are no longer available in the market. Service on the LIFEPAK 15 with Part Number beginning with v15-5 or v15-7 is unaffected.

Stryker will continue to offer service support for this subset of the LIFEPAK 15 as follows:

- All service parts with available inventory can be purchased by our end users
- Transactional service (time and material) is available for non-contract customers
 - If a component has failed on your device, your local Sales Representative should be contacted for support
- Contractual service
 - Stryker will continue to offer contractual service on a yearly basis only
 - Preventive maintenance will continue to be done on devices less than eight (8) years old. After this point, we will cease to conduct preventative maintenance and shift to device inspections
 - If a component fails on your device, please contact your local Sales Representative for support. A pro-rated credit for any pre-paid service will be provided should a unit become non-serviceable due to part availability

It is important to note that the LIFEPAK 15 has an expected life of eight (8) years from the date of manufacture. If you are uncertain of the manufacture date of your products, please contact your local Sales Representative for a full fleet assessment.

We want to ensure the highest quality products and services for our customers. As such, it is important to know that Stryker is the only FDA-approved service provider for our products. We do not contract with third party service providers, nor will we be providing them with any additional parts for these repairs. As such, we cannot guarantee the safety and efficacy of any device that is repaired by a third-party service agency.

Purchase Order Form



Account Manager Jason Roberts
 Cell Phone _____

Purchase Order Date _____
 Expected Delivery Date 9/1/20
 Stryker Quote Number 10241702

BILL TO		CUSTOMER #
Company Name	Bazetta Fire Dept	1074208
Contact or Department	Brad Hall	
Street Address	3000 Warren Meadville Rd	
Add'l Address Line	Cortland, OH 44410	
City, ST ZIP	(330) 442-1212	
Phone		

SHIP TO		CUSTOMER #
Company Name	Bazetta Fire Dept	1074208
Contact or Department	Brad Hall	
Street Address	3000 Warren Meadville Rd	
Add'l Address Line	Cortland, OH 44410	
City, ST ZIP	(330) 442-1212	
Phone		

Authorized Customer Initials _____

Authorized Customer Initials _____

DESCRIPTION	QTY	TOTAL
Reference Quote: 10241702	1	\$ 5,833.94
TOTAL*		\$ 5,833.94 -

Accounts Payable Contact Information

Name: _____
 Email: _____
 Phone: _____

Authorized Customer Signature

Printed Name: _____
 Title: _____
 Signature: _____
 Date: _____

Attachment: Stryker Quote Number 10241702

Stryker Terms and Conditions
www.strykeremergencycare.com/terms

* Sales or use taxes on domestic (USA) deliveries will be invoiced in addition to the price of the goods and services on the Stryker Quote

FINLEY FIRE EQUIPMENT

Ron Danadic - Sales Representative

Cell/330-720-0635

Email rdanadic@finleyfire.com

Price Quotation

Quote Date 8/6/2020

Valid For 30 Days

F.O.B.

Quote Number 204Cr1

Terms 10 Days

Est. Ship Date ASAP

Quoted To: Bazetta Fire Department

Qty.	Part Number and Description	Unit Price	Line Total
1.	Hurst Edraulics Package		\$29,250
	Includes: SP555e2 Spreader, S788E2 Cutter, R421E2 Ram, AC Adapter, 2 batteries/tool and 1 charger/tool		
1	Hurst Strong Arm Kit 2 batteries and charger	\$5,800	\$5,800

Est. Freight Charge N/A



S 377E2 CUTTER

part #: 272025000

THIS CUTTER IS LIKE A GREAT WHITE ON STEROIDS.

The large blade opening gives this cutter quite a bite. The S377E2 conveniently rips through metal and gives you a huge edge in extrications. Move over competition, or you'll get hurt.

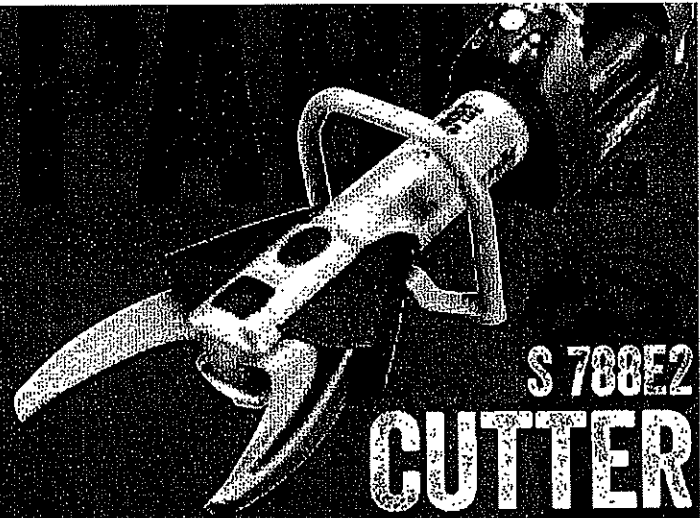

S 788E2 CUTTER

part #: 272788000

THIS WIDE OPENING S 788E2 DEVOURS ANYTHING IN ITS WAY.

The cutter can get its jaws around just about anything. With a 7.87-inch opening, it can cut through current vehicle construction as well as future construction with ease. The perfect hero for any rescue team.

S 377E2 TECHNICAL SPECIFICATIONS

- Length: 36.8 in / 934 mm
- Width: 9.33 in / 237 mm
- Height: 11.1 in / 281 mm
- Weight: 42.6 lbs / 19.3 kg
- Cutter Opening: 8.11 in / 206 mm
- NFPA Cutter Rating: A7/B8/C7/D7/E8
- NFPA 1936 2015 Compliant: Yes
- IP Rating: IP54

FEATURES AND BENEFITS

- Features a wide 8.1-inch blade opening, larger than other lightweight cutters
- Curved blade geometry pulls materials to the back of the blade area for fast, clean action
- Each tool package comes with two batteries and one charger

S 788E2 TECHNICAL SPECIFICATIONS

- Length: 38.9 in / 988 mm
- Width: 10.5 in / 266 mm
- Height: 11.1 in / 281 mm
- Weight: 50 lbs / 22.7 kg
- Cutter Opening: 7.87 in / 200 mm
- NFPA Cutter Rating: A8/B9/C8/D9/E9
- NFPA 1936 2015 Compliant: Yes
- IP Rating: IP54

FEATURES AND BENEFITS

- Wide cutter opening at 7.87 inches
- Highest cutting performance in the relevant work area
- Unique blade geometry with 6.02-inch blade reach
- Built for the high-strength steel of today's and tomorrow's vehicles
- Each tool package comes with two batteries and one charger

HURST
JAWS OF LIFE



SP 555E2 SPREADER

part #: 271555000

THE SPREADER THAT WEIGHS LESS BUT GIVES YOU SO MUCH MORE.

Our new eDRAULIC® spreader is 16% lighter and still gives you 14% more power than its predecessor. You can get the job done and make the rescue quicker than ever. Its "Shark Tooth" removable tips have four rows of shark-like teeth to bite and hold onto any material. Add that to its li-ion never-say-die battery and you know you've got the right power and speed for any job.

TECHNICAL SPECIFICATIONS

- Length: 39.4 in / 1,002 mm
- Width: 10.4 in / 265 mm
- Height: 11 in / 280 mm
- Weight: 44.1 lbs / 20 kg
- Spreading Distance: 28.7 in / 730 mm
- Max Spreading Force: 147,924 lbs / 658 kN
- Max Pulling Force: 13,039 lbs / 58 kN
- NFPA HSF: 16,186 lbs / 72 kN
- NFPA LSF: 11,016 lbs / 49 kN
- NFPA HPF: 10,341 lbs / 46 kN
- NFPA LPF: 6,295 lbs / 28 kN
- NFPA 1936 2015 Compliant: Yes
- IP Rating: IP54

FEATURES AND BENEFITS

- Enhanced performance — 16% lighter and has 14% more power than its predecessor
- Single integrated cylinder body design
- Squeezing plates built into the arms
- "Shark Tooth" removable tips offer multifunctional design, with four rows of shark-like teeth for maximum performance and gripping
- Each tool comes with two li-ion rechargeable batteries and one charger
- If needed, you can plug it in for unstoppable run time with a 110V adapter

Optional Accessory



Spreader Stability Plate Kit

Part # 101C085

81-67-20



KSV11

Weight 29.3 lbs. (13.3 kg)

HURST
JAWS OF LIFE

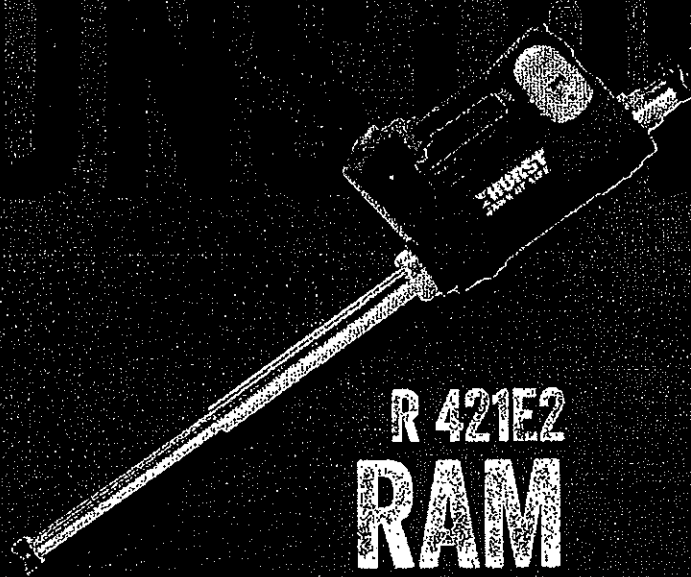

R 421E2 RAM

part #: 274085000

EXTENDS UP TO 53"

The R 421E2 is the industry's first battery-powered telescopic rescue ram. And while it is extremely compact, it offers enough strength to pack a wallop. The newly designed, sharp claws at both ends can be rotated 360 degrees, enabling you to apply the ram effectively in almost any precarious situation.



R 422E2 RAM

part #: 274087000

EVERYONE NEEDS A LITTLE MORE RAM.

The R 422E2 Ram is our new improved battery-powered telescopic rescue ram. With an extended length of 59.1 inches, this tool can give you room to spare. It has sharp claws at both ends that rotate 360 degrees, so you can use it in even the trickiest situations.

TECHNICAL SPECIFICATIONS

- Ram Tool: R 421E2
- Part #: 274085000
- Length Retracted: 23.5 in / 597 mm
- Length Extended: 53 in / 1,347 mm
- Width: 5.3 in / 135 mm
- Height: 12.3 in / 313 mm
- Weight: 41.9 lbs / 19 kg
- Stroke:
 - Piston 1: 15.2 in / 387 mm
 - Piston 2: 14.3 in / 363 mm
 - Piston 3: 29.5 in / 750 mm
- Max Pushing Force:
 - Piston 1: 28,600 lbs / 127 kN
 - Piston 2: 13,500 lbs / 60 kN
- NFPA 1936 2015 Compliant: Yes
- IP Rating: IP54

- Ram Tool: R 422E2
- Part #: 274087000
- Length Retracted: 29.5 in / 750 mm
- Length Extended: 59.1 in / 1,500 mm
- Width: 5.3 in / 135 mm
- Height: 12.3 in / 313 mm
- Weight: 45.9 lbs / 20.8 kg
- Stroke:
 - Piston 1: 15.2 in / 387 mm
 - Piston 2: 14.3 in / 363 mm
 - Piston 3: 29.5 in / 750 mm
- Max Pushing Force:
 - Piston 1: 28,600 lbs / 127 kN
 - Piston 2: 13,500 lbs / 60 kN
- NFPA 1936 2015 Compliant: Yes
- IP Rating: IP54

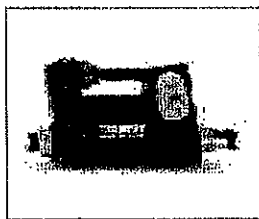

Optional Accessory

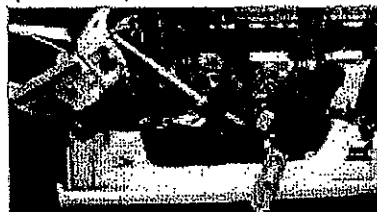

L&S-C Ram Support

Part #: 247R028



STRONGARM

BY HURST JAWS OF LIFE

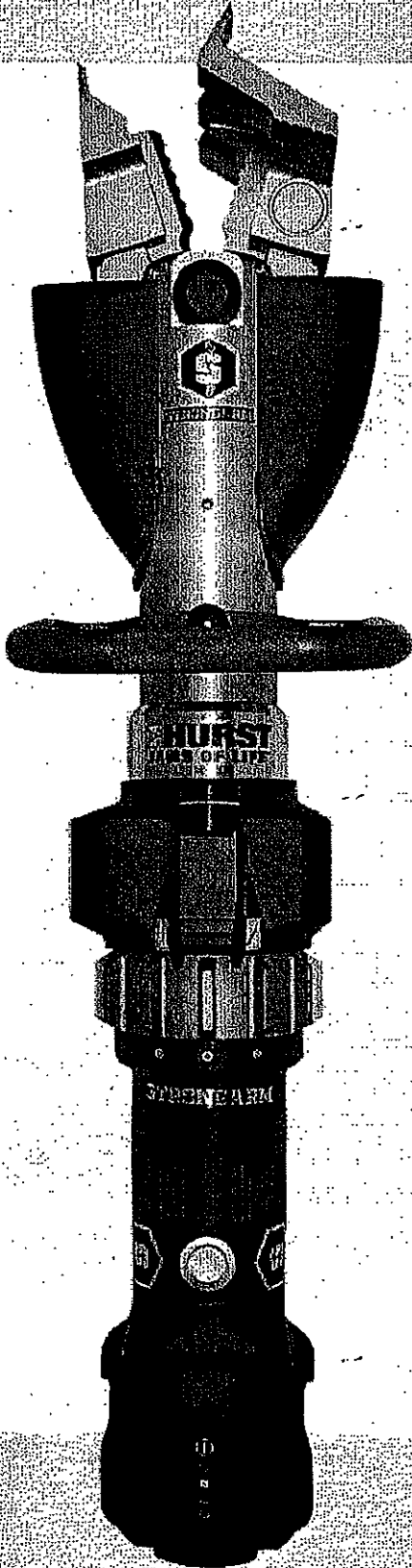
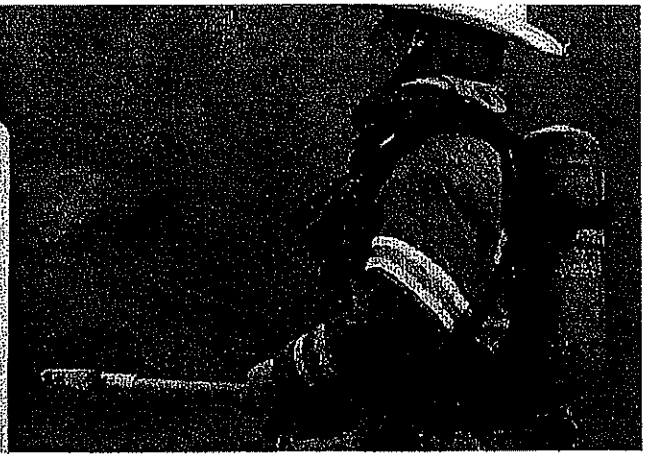

You need to arm yourself properly. And if you're a firefighter in a tactical rescue or rapid intervention team, the StrongArm™ from Hurst Jaws of Life can help you do just that. It provides you one powerful, yet portable tool that can cut, lift, spread and replace crowbars, Halligan bars, wire cutters, axes, and so much more. Just make sure wherever you go, you have your StrongArm.

FEATURES AND BENEFITS

- Designed to operate in heat and smoke environments
- Built in Picatinny accessory rail (Note: Flashlight not included with standard equipment.)
- Four position handle
- Easy tip change-out using large buttons
- StrongArm tool comes in blue for the municipal fire market and black for the law enforcement market
- Cuts 3/8" rebar, Grade 43 chain, 2" x 4" wood
- Protection Class IP54
- Each tool comes with two sets of tips (door opener and combination), two Li-Ion rechargeable batteries and one charger

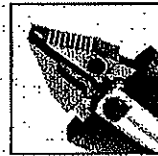

TECHNICAL SPECIFICATIONS

- **LENGTH:**
31.3 in / 796 mm with combi tips
30.5 in / 775 mm with door opener tips
- **WIDTH:** 7.7 in / 195 mm
- **HEIGHT:** 8.3 in / 210 mm
- **WEIGHT:**
21.4 lbs / 9.7 kg without tips, without battery
24.3 lbs / 11.0 kg with combi tips, without battery
25.8 lbs / 11.7 kg with door opener tips, without battery
- **SPREADING DISTANCE:**
8.5 in / 215 mm with combi tips
7.2 in / 183 mm with door opener tips
- **HIGHEST SPREADING FORCE:** 6,744 lbs / 30 kN
- **LOWEST SPREADING FORCE:** 5,395 lbs / 24 kN
- **CUTTING RATING:** A5 / B3 / C5 / D6 / E6
- **CUTTER OPENING:** 8.2 in / 207 mm
- **BATTERY WEIGHT:** 2.7 lbs / 1.2 kg

Part # 273100000
SUBJECT TO REVISION (07.15.15)



E8FC320D

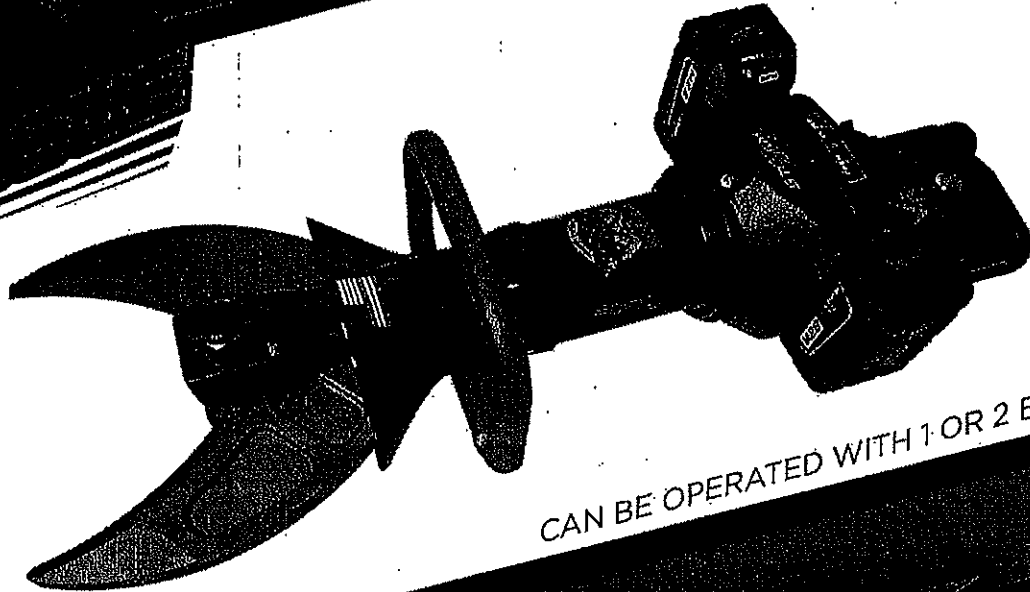

CAN BE OPERATED WITH 1 OR 2 BATTERIES!

EQUIPMENT SPEC'S	STANDARD	METRIC
LENGTH	34.6 IN	878.8 MM
HEIGHT	7.0 IN	177.8 MM
WIDTH	10.75 IN	273.1 MM
WEIGHT		
NO BATTERIES	58.5 LBS	26.5 KG
ONE BATTERY	60.8 LBS	27.6 KG
TWO BATTERIES	63.1 LBS	28.6 KG
MAX. BLADE OPENING	8.60 IN	218.4 MM
MAX. CUT LENGTH	6.38 IN	162.1 MM
POWER SOURCE	28 VOLT MILWAUKEE BATTERY	
NFPA 1936-2015 COMPLIANT	YES	
NFPA CUT TEST	A9, B9, C9, D9, E9	
IP RATING	54	

* EVERY COMPONENT IN THE STORM SERIES IS COVERED BY THE TNT FOREVER WARRANTY, EXCEPT THE BATTERIES AND BATTERY CHARGER WHICH HAVE A THREE YEAR WARRANTY

TNT RESCUE SYSTEMS, INC.
2490 West Oak Street
Ashippun, WI 53003



BUILT TO RESCUE



E510028_D

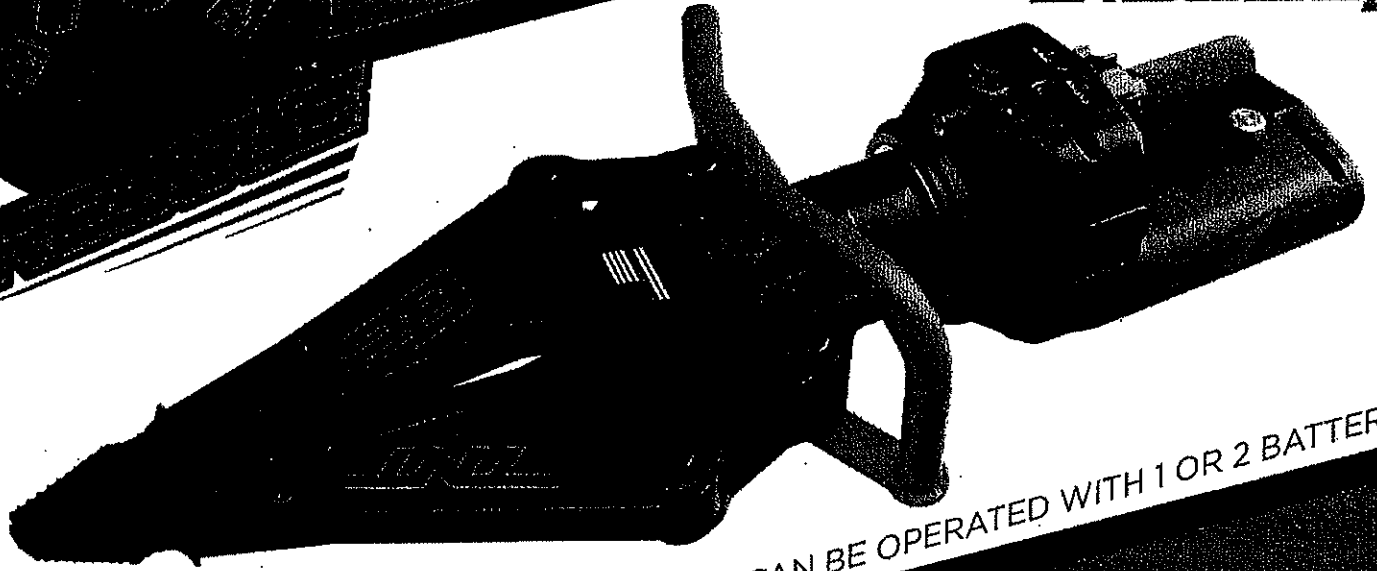

CAN BE OPERATED WITH 1 OR 2 BATTERIES!

TECHNICAL SPECS	STANDARD	METRIC
LENGTH	36.6 IN	929.9 MM
HEIGHT	8.9 IN	226 MM
WIDTH	13.6 IN	345.4 MM
WEIGHT		
NO BATTERIES	51.8 LBS	23.5 KG
ONE BATTERY	54.1 LBS	24.5 KG
TWO BATTERIES	56.4 LBS	25.6 KG
MAX. SPREAD DISTANCE	28.0 IN	711.2 MM
MAX. SPREAD FORCE RANGE	56,128 - 228,126 LBS	249 - 1,014 KN
MAX. PULL FORCE	25,512 LBS	113 KN
POWER SOURCE	28 VOLT MILWAUKEE BATTERY	
NFPA 1936-2015 COMPLIANT	YES	
IP RATING	54	

EVERY COMPONENT IN THE STERN SERIES IS COVERED BY THE TIT FORFOEVER WARRANTY EXCEPT THE BATTERIES AND BATTERY CHARGER WHICH HAVE A THREE-YEAR WARRANTY.

TNT RESCUE SYSTEMS, INC.
2490 West Oak Street
Ashippun, WI 53003



**BUILT TO
RESCUE**



ER40

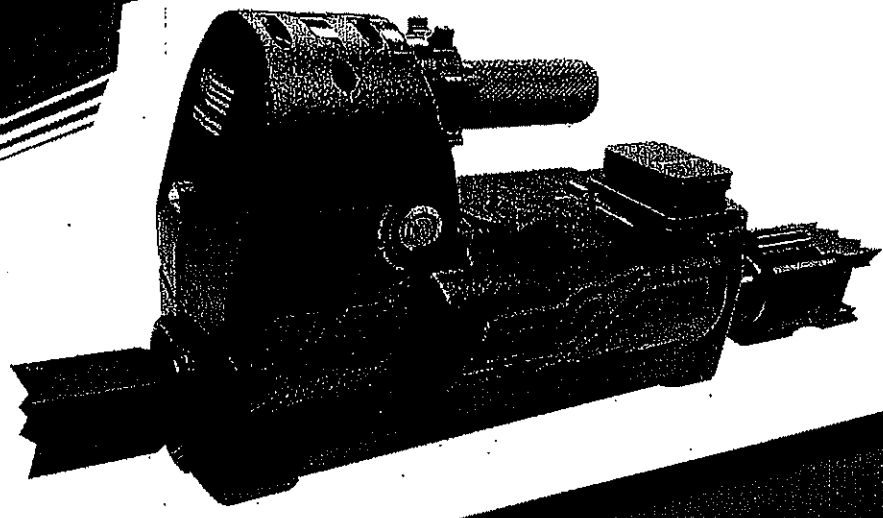

UNIT OF MEASURE	IMPERIAL	METRIC
EXTENDED LENGTH	41.00 IN	1,041.4 MM
CLOSED LENGTH	25.50 IN	647.7 MM
HEIGHT	10.75 IN	273 MM
WIDTH	8.10 IN	205.7 MM
WEIGHT		
NO BATTERY	40.6 LBS	18.4 KG
ONE BATTERY	43.0 LBS	19.5 KG
MAX. PUSH FORCE	32,980 LBS	145 KN
MAX. PULL FORCE	7,800 LBS	34.7 KN
POWER SOURCE	28 VOLT MILWAUKEE BATTERY	
NFPA 1936-2015 CERTIFIED	YES	
IP RATING	54	

* EVERY COMPONENT IN THE STORM SERIES IS COVERED BY THE TNT FOREVER WARRANTY, EXCEPT THE BATTERIES AND BATTERY CHARGER WHICH HAVE A THREE-YEAR WARRANTY

TNT RESCUE SYSTEMS, INC.
 2490 West Oak Street
 Ashippun, WI 53003



BUILT TO RESCUE



EBFCC28_D

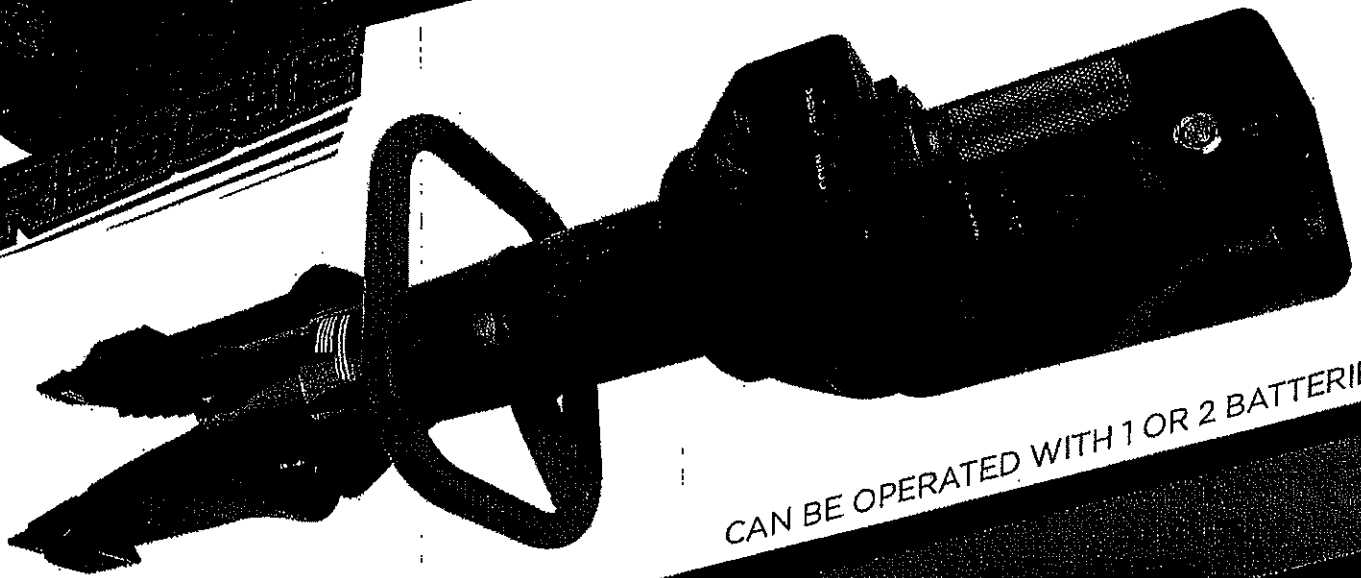

CAN BE OPERATED WITH 1 OR 2 BATTERIES!

TECHNICAL SPECS	STANDARD	METRIC
LENGTH	37.5 IN	952.5 MM
HEIGHT	9.5 IN	241.3 MM
WIDTH		
NO BATTERIES	10.5 IN	266.7 MM
ONE BATTERY	11.38 IN	289 MM
TWO BATTERIES	12.6 IN	320 MM
WEIGHT		
NO BATTERIES	50.7 LBS	22.9 KG
ONE BATTERY	52.9 LBS	23.9 KG
TWO BATTERIES	55.1 LBS	24.9 KG
MAX. SPREAD DISTANCE	16.64 IN	422.7 MM
MAX. SPREAD FORCE	286,000 LBS	1,272 KN
MAX. CUT FORCE	156,000 LBS	694 KN
POWER SOURCE	26 VOLT MILWAUKEE BATTERY	
NFPA 1936-2015 COMPLIANT	YES	
NFPA CUT TEST	A8, B9, C8, D8, E9	
IP RATING	54	

* EVERY EQUIPMENT IN THE STORM SERIES IS COVERED BY THE FOREVER WARRANTY EXCEPT THE BATTERIES AND BATTERY CHARGERS WHICH HAVE A THREE YEAR WARRANTY.

TNT RESCUE SYSTEMS, INC.
2490 West Oak Street
Ashippun, WI 53003



BUILT TO RESCUE





FOREVER WARRANTY



HYDRAULIC RESCUE TOOLS

Should any TNT Rescue Systems, Inc. manufactured product purchased from TNT Rescue Systems, Inc. or an authorized representative of TNT Rescue Systems, Inc. fail to perform as originally intended due to wear or workmanship, return it to TNT Rescue Systems, Inc. with postage prepaid, and we will either replace or repair it, at our option, for as long as you own it - no if's, and's or but's. TNT Rescue Systems, Inc. recommends annual servicing of tools by a TNT Rescue Systems, Inc. authorized service technician.

This warranty does not apply to:

- 1) ABUSE
- 2) ANY ALTERATIONS NOT COMPLIANT WITH TNT RESCUE SYSTEMS, INC. FACTORY SPECIFICATIONS AND SERVICE PROVIDED BY UNAUTHORIZED TECHNICIANS.

This warranty is limited to the cost of repair or replacement at the option of TNT Rescue Systems, Inc. of any defective product and it shall in no event include incidental or consequential commercial damages of any kind.

This warranty is an exclusive warranty and TNT Rescue Systems, Inc. makes no other warranties of any kind or nature whatsoever, expressed or implied, with respect to the products manufactured and/or sold by it. TNT Rescue Systems, Inc. specifically disclaims any warranties of fitness for a particular purpose or merchantability.

No distributor, agent, employee or representative of TNT Rescue Systems, Inc. may alter this warranty in any way.

TNT Rescue System, Inc.'s Forever Warranty also remains in effect when used with other manufactures equipment!

*Any product not manufactured by TNT Rescue Systems, Inc. carries a 3 year warranty.

STORM SERIES BATTERY TOOLS

Should any TNT Rescue Systems, Inc. manufactured product purchased from TNT Rescue Systems, Inc. or an authorized representative of TNT Rescue Systems, Inc. fail to perform as originally intended due to wear or workmanship, return it to TNT Rescue Systems, Inc. with postage prepaid, and we will either replace or repair it, at our option, for as long as you own it - no if's, and's or but's. The Storm2 series forever warranty also includes the lexan body, electrical components, motor, gearbox and wiring harness. TNT Rescue Systems, Inc. recommends annual servicing of tools by a TNT Rescue Systems, Inc. authorized service technician.

This warranty does not apply to:

- 1) ABUSE
- 2) ANY ALTERATIONS NOT COMPLIANT WITH TNT RESCUE SYSTEMS, INC. FACTORY SPECIFICATIONS AND SERVICE PROVIDED BY UNAUTHORIZED TECHNICIANS.
- 3) BATTERIES AND BATTERY CHARGERS

This warranty is limited to the cost of repair or replacement at the option of TNT Rescue Systems, Inc. of any defective product and it shall in no event include incidental or consequential commercial damages of any kind.

This warranty is an exclusive warranty and TNT Rescue Systems, Inc. makes no other warranties of any kind or nature whatsoever, expressed or implied, with respect to the products manufactured and/or sold by it. TNT Rescue Systems, Inc. specifically disclaims any warranties of fitness for a particular purpose or merchantability.

No distributor, agent, employee or representative of TNT Rescue Systems, Inc. may alter this warranty in any way.

TNT RESCUE SYSTEMS, INC.
2490 West Oak Street
Ashippun, WI 53003

**BUILT TO
RESCUE**





gary shonkwiler <amkus.ohio@gmail.com>

Amkus Battery Tool Quote

1 message

gary shonkwiler <amkus.ohio@gmail.com>
To: ppelley@bazettatwp.org

Thu, Aug 27, 2020 at 6:14 PM

8-27-2020

Bazetta Twp. Fire Department
Phillip Pelley

Mr. Pelley,
I'm pleased to quote the following Amkus Rescue Equipment,
ION Battery Tools

1 Model IC750 7" Cutter, Swivel and lighted handle.	\$ 9,585.00
1 Model IS320, 32" Spreader, Lighted handle and removable tips.	10,750.00
2 Extended Reach tips for the spreader.	975.00
1 Model ITR230 Ram, Swivel handle.	7,470.00
1 AMK-TCE-KIT, Ram extension kit, includes: 1-10", 1-18" and 1-27" Ram extension	1,250.00
1 Model ICT716, Combi tool, removable tips.	10,080.00
8 DeWalt 20/60 9 Amp hour flex volt batteries.	205.00 ea. \$ 1,640.00
1 DeWalt fast / smart 4 bay charger.	265.00

Freight: 250.00

When you purchase an Amkus Battery tool system you can chose 1 of the DeWalt FlexVolt Fire Rescue Kits on page 9, 10 or 11 in the Amkus catalog at no charge.

Any questions, please let me know, When you are ready for a demo of the equipment let me know and we would be pleased to show you the Amkus Battery Tools.

Training included when delivered. NO CHARGE

Thank you,

Gary Shonkwiler

Western Ohio Rescue Supply

BATTERY

ion
Battery Powered Tools

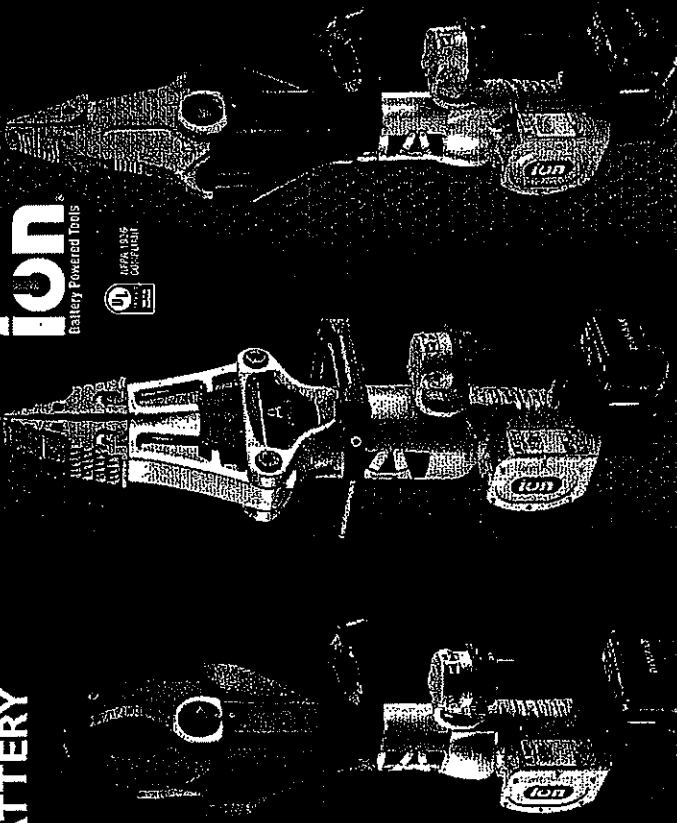

iCS50

iS280

iCTS16

AMKUS INNOVATION

Compact, all-metal bodies designed to access tight spaces and require less room on the apparatus

DEWALT FLEXVOLT battery powered so batteries can be shared with other fire-rescue tools like saws, lights and drills

High Intensity LED lights located in the handle for increased visibility (standard on cutter and combi)

UL Certified NFPA 1936 Compliant - 100% tested as a battery tool

iCS50 CUTTER

- Blade and center bolt design allow access to the difficult cuts
- Rotating handle allows tool to be repositioned with minimal effort

iS240 & iS280 SPREADERS

- 24" and 28" Spreaders are compact, yet powerful

iCTS16 COMBI TOOL

- A versatile tool for engines, rescue trucks, or ambulances
- Rotating handle allows tool to be repositioned with minimal effort

ITR230 RAM

- Highest pushing force available in a battery-powered ram
- Extensions available for a maximum extended length of 50"

Extended Reach Tips (ERT) increase the spread an additional 8" without significant loss of power

- Gator Tips and ERT's utilize a push button release, so they're easy to install or remove, even with gloved hands

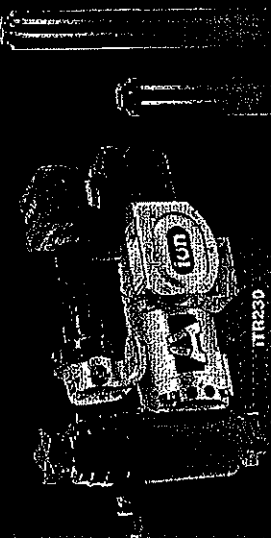

ITR230

ION Cutter iCS50 NFPA 1936 Compliant

Length	30.3 inches (772 mm)
Width	6.5 inches (165 mm)
Height	15.5 inches (393 mm)
Weight (incl. battery)	12.5 lbs (5.7 kg)
Color Overlay	5.8 inches (147 mm)
Stroke Length	4.5 inches (114 mm)
Battery	DEWALT FLEXVOLT™
Factory Voltage	60V

ION 24" Spreader iS240 NFPA 1936 Compliant

Length	37.2 inches (945 mm)
Width	5.8 inches (147 mm)
Height	11.0 inches (280 mm)
Weight (incl. battery)	14.0 lbs (6.3 kg)
Weight (incl. battery) w/ optional lighted handle	16.0 lbs (7.3 kg)
Color Overlay	4.6 inches (117 mm)
Stroke Length	4.5 inches (114 mm)
Max Spreading Distance (with optional ERT tips)	32 inches (813 mm)
Highest Spreading Force (with optional ERT tips)	43,500 lbs (19,740 kg)
Lowest Spreading Force (LSF)	7,410 lbs (3,363 kg)
Max Spreading Force (LSF)	38,120 lbs (17,290 kg)
Highest Pushing Force (LSF)	10,550 lbs (4,783 kg)
Lowest Pushing Force (LSF)	6,240 lbs (2,828 kg)
Battery	DEWALT FLEXVOLT™
Factory Voltage	60V

ION Combi Tool iCTS16 NFPA 1936 Compliant

Length	33.5 inches (851 mm)
Width	6.5 inches (165 mm)
Height	15.5 inches (393 mm)
Weight (incl. battery)	12.5 lbs (5.7 kg)
Color Overlay	5.8 inches (147 mm)
Stroke Length	4.5 inches (114 mm)
Max Spreading Distance	32 inches (813 mm)
Highest Spreading Force (LSF)	43,500 lbs (19,740 kg)
Lowest Spreading Force (LSF)	7,410 lbs (3,363 kg)
Max Spreading Force (LSF)	38,120 lbs (17,290 kg)
Highest Pushing Force (LSF)	10,550 lbs (4,783 kg)
Lowest Pushing Force (LSF)	6,240 lbs (2,828 kg)
Battery	DEWALT FLEXVOLT™
Factory Voltage	60V

ION Ram ITR230 NFPA 1936 Compliant

Length	37.8 inches (960 mm)
Width	6.5 inches (165 mm)
Height	11.4 inches (290 mm)
Weight (incl. battery)	12.5 lbs (5.7 kg)
Color Overlay	5.8 inches (147 mm)
Stroke Length	4.5 inches (114 mm)
Max Spreading Distance	32 inches (813 mm)
Highest Spreading Force (LSF)	43,500 lbs (19,740 kg)
Lowest Spreading Force (LSF)	7,410 lbs (3,363 kg)
Max Spreading Force (LSF)	38,120 lbs (17,290 kg)
Highest Pushing Force (LSF)	10,550 lbs (4,783 kg)
Lowest Pushing Force (LSF)	6,240 lbs (2,828 kg)
Battery	DEWALT FLEXVOLT™
Factory Voltage	60V



9 Inch Cut Off Saw iC9

FLEXVOLT™ powered cut-off saw makes cuts up to 2-1/4 inch deep, wide (83 and efficient single pass cuts and score in concrete, steel and rebar.

SEE ALL 11 AMKUS FLEXVOLT™ FIRE-RESCUE KITS ON PAGES 8-11

AMKUS
10000
10000

Corporate Offices / Warehouses 2673 Culver Avenue Kettering, Ohio 45429 Ph. 937-290-0522

August 12, 2020
 Bazetta Township Fire Department
 Attn: Rescue Tool Committee Chairman Mr. Hanson
 3000 Warren Meadville Road
 Cortland, Ohio 44410
 (330)240-5866
AHanson@BazettaTwp.org

Dear Mr. Hanson,

Howell Rescue Systems hereby submits the following quotation on the Genesis Rescue Systems. This is provided based on our recent contact. Should you require any additional items or information, do not hesitate to contact our office or myself.

(1) Genesis E-Force 3.0 Battery Powered C236 Next Gen. Cutter w/battery (newly released Milwaukee 5ah battery) 8.3 in. opening, and ultra-high strength replaceable blade inserts & only 51.8 lbs. N.F.P.A. #1936 compliant with NFPA rating of A8-B9-C8-D9-E9, commercially available batteries	\$11,445.00
(1) Genesis E-Force 3.0 Battery Powered S53 Spreader w/battery (newly released Milwaukee 5ah battery) 32 in. opening w 112,725 lbs. max spreading force, multi-functional spreading tip & only 46.1 lbs. N.F.P.A. #1936 compliant, commercially available batteries	\$11,414.00
(1) Genesis E-Force 3.0 Battery Powered 11C Combination Tool w/battery (newly released Milwaukee 5ah battery) 11.4 in. opening w 8,100 lbs. spreading force N.F.P.A. #1936 compliant with NFPA rating of A6-B7-C6-D7-E7	\$10,575.00
(1) Genesis E Force 2.0 Battery Powered 22-54 Telescopic Ram w/battery (newly released Milwaukee 5ah battery) 54 in. opening w 24,279 lbs. maximum spreading force. N.F.P.A. #1936 compliant, commercially available batteries	\$9,785.00
(4) 5Ah Milwaukee 28v Spare Batteries	4 @ \$230.00 Total \$920.00
(1) 3-Bay charger	\$300.00
(1) 1-Bay Charger	\$100.00

All models of the Genesis E Force Battery Rescue Tools include the following:

- Fully encapsulated aluminum fluid reservoirs for extreme durability vs. rubber bladders.
- Power buttons are of all steel construction for longevity and durability vs. plastic manufactured buttons.
- A full 3-year manufacturer's warranty on the Milwaukee 28V 5AH battery with an ambient operating temperature of 0°F to 125°F
- A high-quality brushless motor to reduce heat buildup and increase efficiency vs. a less efficient brushed motor.
- Low RPM / auto shutoff feature to increase battery efficiency and extend brushless motor life.

HRS can also provide both horizontal and vertical mounting brackets for all of the tools listed above.

Howell Rescue Systems also offers a used rescue tool trade in program for your old rescue system. We carry a fluctuating inventory of used rescue tools as well as new 5,000 psi hose, couplers and fluid. In the event your dept. experiences an out of service issue with your existing system, tools, hose, couplers or fluid HRS would provide a loaner unit to quickly get you back in service. This would save any unnecessary expenditure toward a system that is being replaced. Loaners would be based on our inventory availability, I have included a partial inventory photo below. As when HRS has provided loaner tools in the past, there would be no charge for this loaner tool. The loaner tool could stay with your dept. until your new Genesis equipment would arrive.

GENESIS

RESCUE SYSTEMS

Dräger

Corporate Offices / Warehouses 2673 Culver Avenue Kettering, Ohio 45429 Ph. 937-290-0522

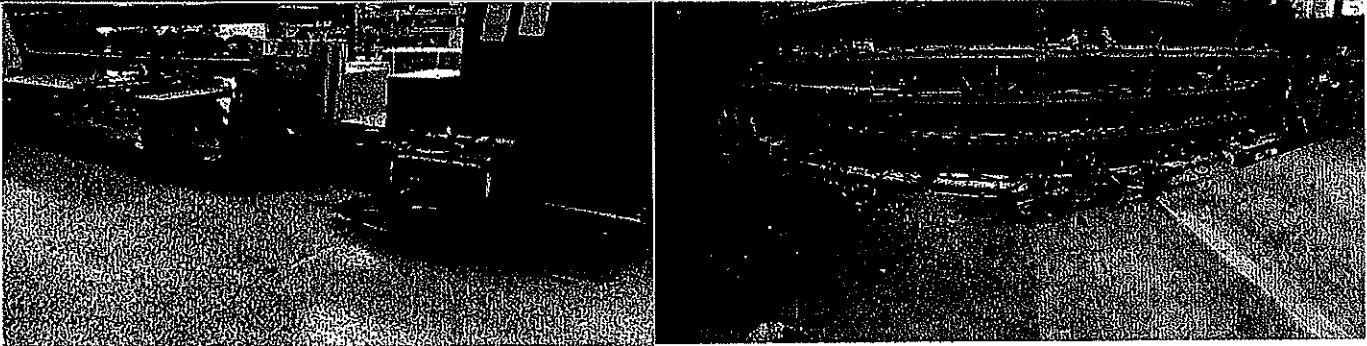

Howell Rescue Systems is geared directly toward sales, service and training. After your new system is delivered the relationship between your department and our company begins. In regards to training on your new equipment, I would deliver the new tools and go through a simple operations training of the systems. A hands-on train the trainer type environment is typically very successful for this portion. This allows me the time to spend one on one with a smaller group which is typically your training personnel. Though many of the techniques would be familiar to a department of your size it would still give the chance to share some information & techniques specific to Genesis.

If you have any questions or would like to place an order I can be reached at (330) 881-0432. Thank you very much for the opportunity to demonstrate the Genesis system and submit this quotation. I look forward to hearing from you soon.

Prices Good Through: November 12, 2020

Delivery: 90 Days or less normally

Terms: Net 15

F.O.B.: Cortland, Ohio -No Shipping Fees Added

Training Fee: No charge

Sincerely,
Luke Ricketts
Factory Representative-Northeast Ohio
(330) 881-0432
LRicketts@HowellRescue.com

ART.108.778.1



GENESIS

RESCUE SYSTEMS
THE NEXT GENERATION OF EXTRICATION

C236-SL2 EFORCE 2.0

EFORCE 2.0

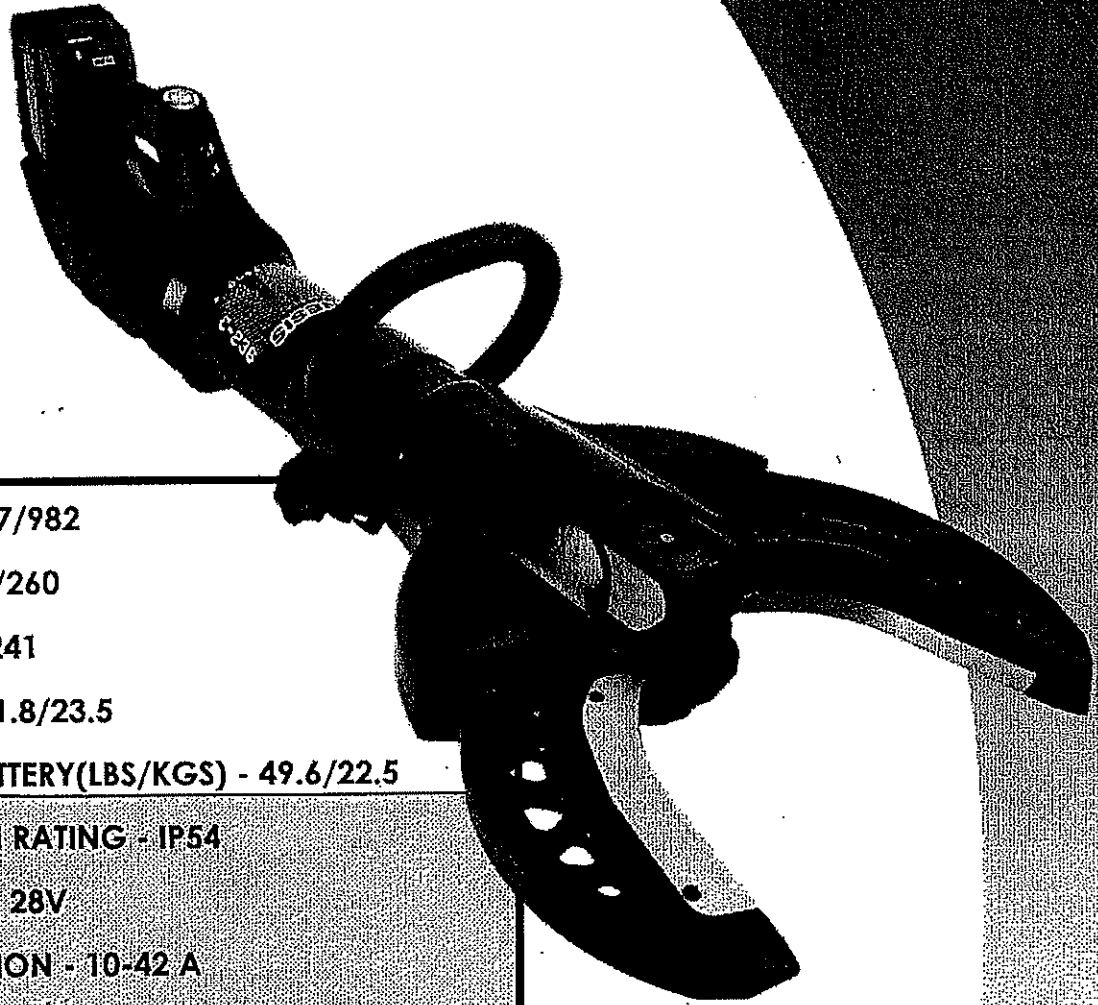

SPECIFICATIONS

LENGTH(IN/MM) - 38.7/982

WIDTH(IN/MM) - 10.2/260

DEPTH(IN/MM) - 9.4/241

WEIGHT(LBS/KGS) - 51.8/23.5

WEIGHT WITH OUT BATTERY(LBS/KGS) - 49.6/22.5

INGRESS PROTECTION RATING - IP54

NOMINAL VOLTAGE - 28V

CURRENT CONSUMPTION - 10-42 A

BATTERY - 28V DC / 3.0 OR 5.0 AH

NOMINAL PRESSURE(Psi/MPa) - 10,000/70

OPENING(IN/MM) - 8.2/210

NFPA 1936 COMPLIANT - YES

NFPA 1936 LEVEL RATING - A8 | B9 | C8 | D9 | E9

DATE: 11-28-2018	REVISION: 11.2018
PBY: GCC	028-713127540-001



ART.107.779.1



GENESIS

RESCUE SYSTEMS

THE NEXT GENERATION OF EXTRICATION

S53 EFORCE 2.0

EFORCE 2.0

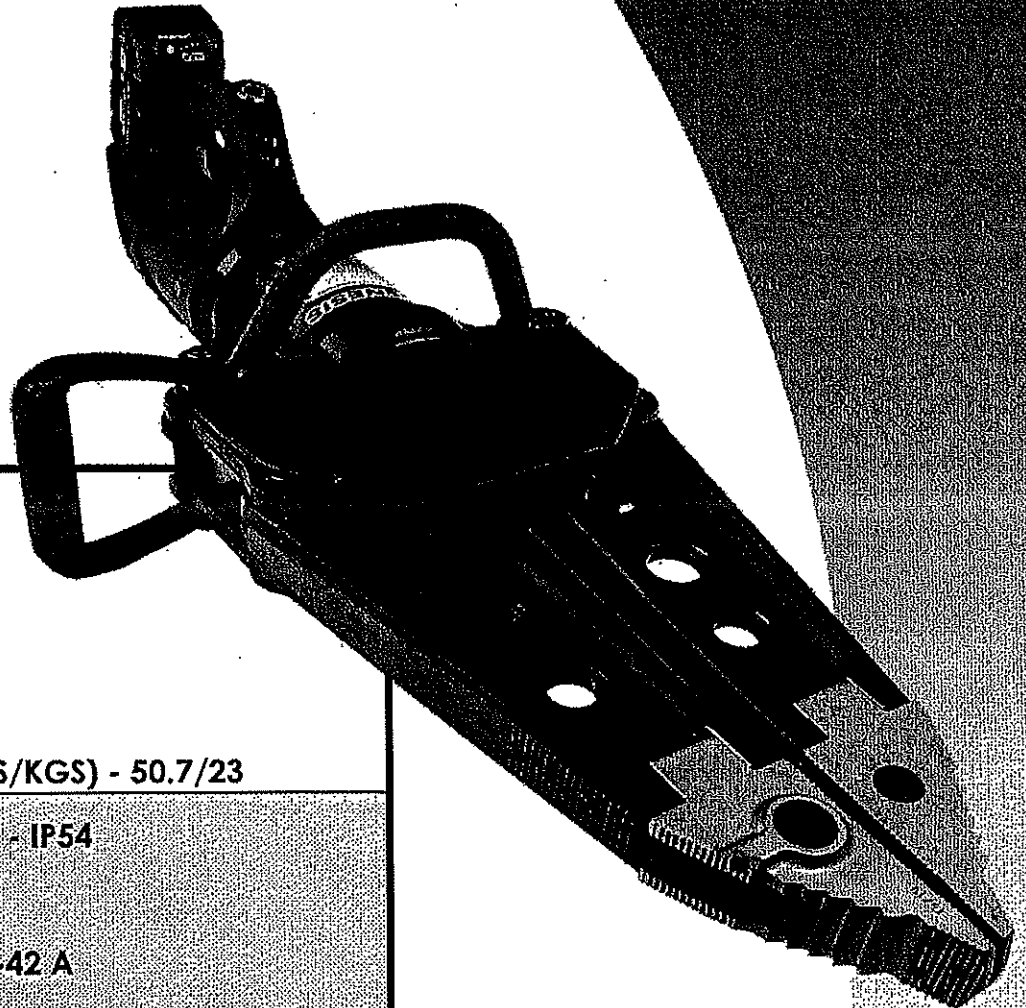

SPECIFICATIONS

LENGTH(IN/MM) - 39.1/993

WIDTH(IN/MM) - 11.7/298

DEPTH(IN/MM) - 9.4/241

WEIGHT(LBS/KGS) - 52.9/24

WEIGHT WITH OUT BATTERY(LBS/KGS) - 50.7/23

INGRESS PROTECTION RATING - IP54

NOMINAL VOLTAGE - 28V

CURRENT CONSUMPTION - 10-42 A

BATTERY - 28V DC / 3.0 OR 5.0 AH

NOMINAL PRESSURE(Psi/MPa) - 10,000/70

SPREADING DISTANCE(IN/MM) - 31.5/800

NFPA 1936 COMPLIANT - YES

NFPA 1936 LEVEL RATING - N/A

LOWEST SPREADING FORCE(LBF/KN) - 11,870/52.8

HIGHEST SPREADING FORCE(LBF/KN) - 18,277/81.3

LOWEST PULLING FORCE(LBF/KN) - 8,678/38.6

HIGHEST PULLING FORCE(LBF/KN) - 14,837/66

DATE: 11-28-2018	REVISION: 11.2018
PBY: GCC	028-713127540-001



ART.107.834.2



GENESIS

RESCUE SYSTEMS
THE NEXT GENERATION OF EXTRICATION

22-54 EFORCE 2.0 TELESCOPIC RAM

EFORCE 2.0

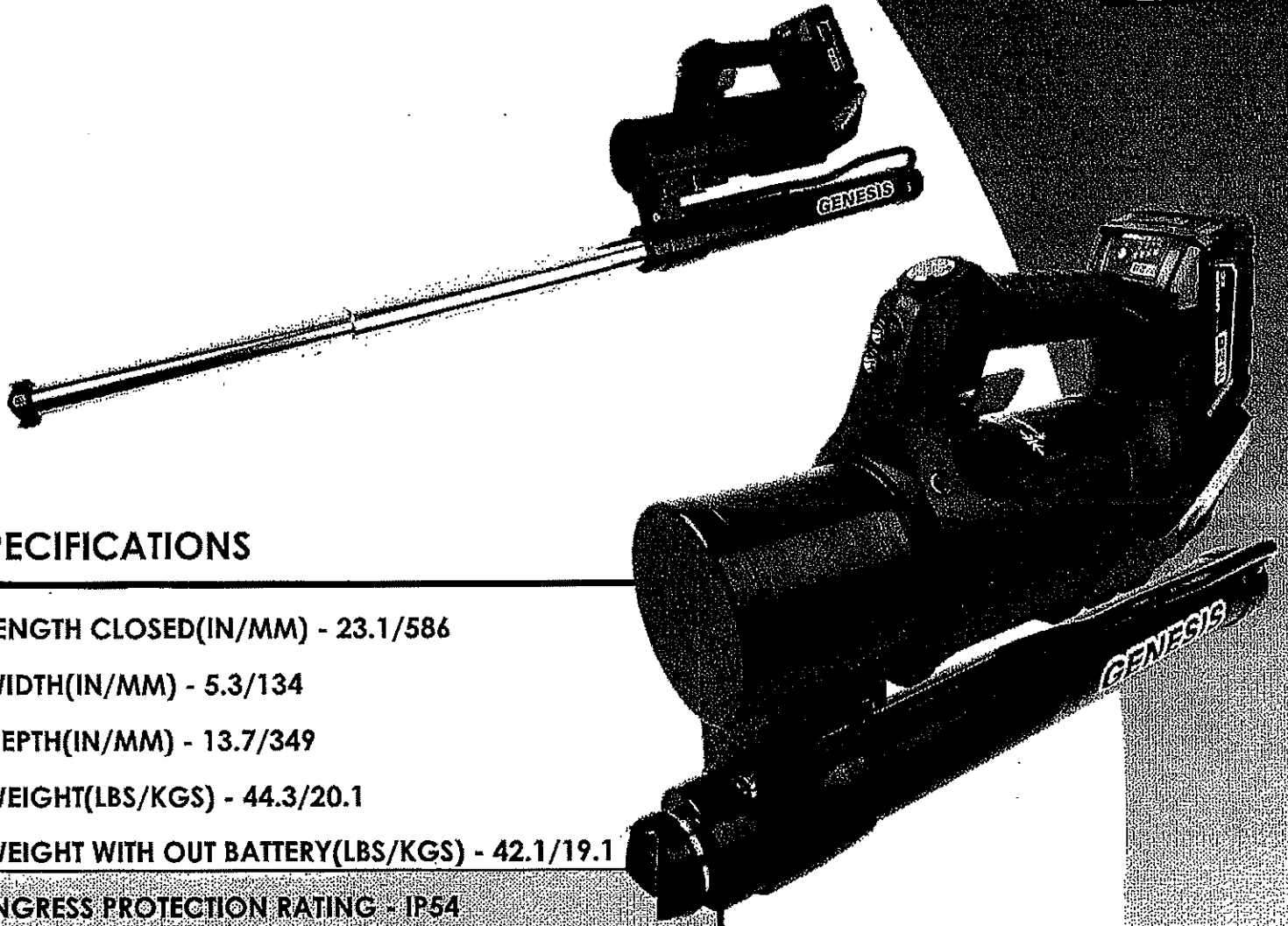

SPECIFICATIONS

- LENGTH CLOSED(IN/MM) - 23.1/586
- WIDTH(IN/MM) - 5.3/134
- DEPTH(IN/MM) - 13.7/349
- WEIGHT(LBS/KGS) - 44.3/20.1
- WEIGHT WITH OUT BATTERY(LBS/KGS) - 42.1/19.1
- INGRESS PROTECTION RATING - IP54
- NOMINAL VOLTAGE - 28V
- CURRENT CONSUMPTION - 10-42 A
- BATTERY - 28V DC / 3.0 OR 5.0 AH
- NOMINAL PRESSURE(Psi/MPa) - 10,000/70
- LENGTH EXTENDED(IN/MM) - 53.5/1360
- STROKE(IN/MM) - 31.5/800
- MAX PUSHING FORCE(LBF/KN) - 24,279/108
- NFPA 1936 COMPLIANT - YES

DATE: 01.29.2019	REVISION: T.2019
PBY: GCC	



Part Number:

ART.108.290.0



GENESIS
RESCUE SYSTEMS

11C-BM1: ART.109.290.0
Ships with Brute Tips Installed

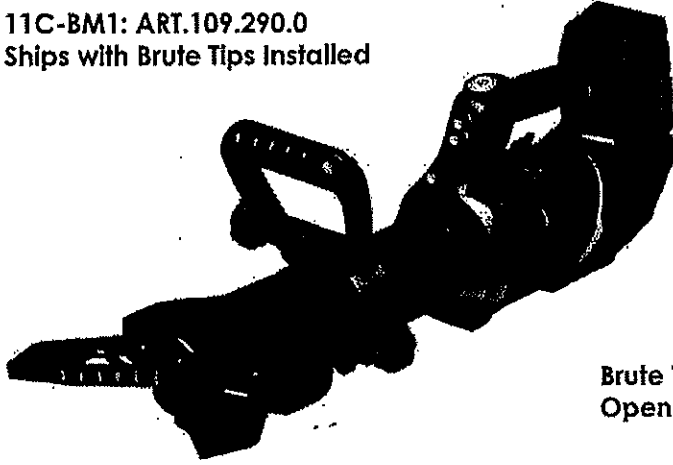

When ordering please specify which tips should be installed.

RIT Tip: ART.109.685.9
Open: 290mm | 11.4 inch

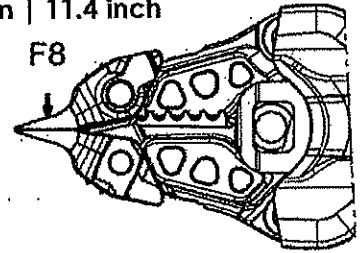

SW Tip: ART.105.189.6
Open: 380mm | 15 inch

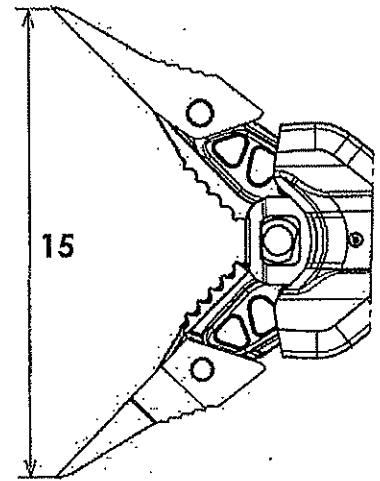

Brute Tip: ART.386.732.3
Open: 285mm | 11.2 inch

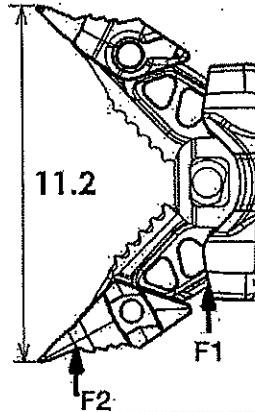

Model:

11C-BM1 w/RIT

Spreading Width	285 mm, 290 mm, 380 mm	11.2 inch, 11.4 inch, 15 inch
Spreading Force	30 - 36 kN	6,750 - 8,100 lbf
Max. Cutting Force	324 kN	72,900 lbf
Pulling Width	320 mm	12.6 inch
Max. Pulling Force	35 - 47 kN	7,875 - 10,575 lbf
Weight (Inclu. Battery, No Tips)	13,3 kg	29.3 lbs
Dimensions (LxWxH)	773 x 192 x 241 mm	30.4 x 7.6 x 9.5
Nominal Pressure	700 bar	10,000 psi
NFPA 1936 Cut Rating		A6 - B7 - C6 - D7 - E7
Ingress Protection Rating		IP54

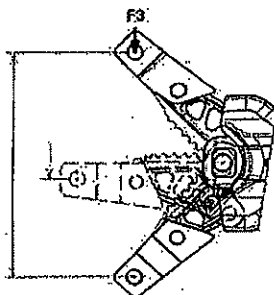
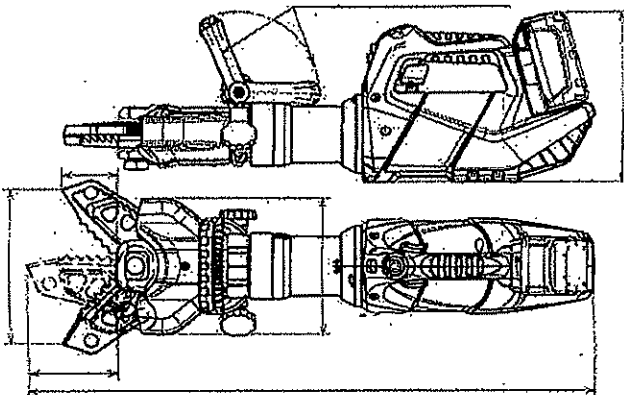

Genesis Rescue Systems
2780 Culver Ave.
Kettering, Ohio 45429
info@genesiscue.com

GENESIS
THE NEXT GENERATION OF CERTIFICATE
WWW.GENESISRESCUE.CO

August 2020 Bazetta Police Department Activity



Published Date: September 7, 2020

Activity	Total
Calls for Service	
Incident Reports Filed	105
Traffic Crash Investigations	6
Number of Persons Arrested	26
Traffic Offenses	17
Traffic Citations Issued	14
Vehicle Miles Traveled	5,643.80
Office Contacts	220

* Numbers are subject to change due to report status and other circumstances

Bozetta Township Police - 2019-2020 Monthly Comparison Chart

2019	Jan	Feb	Mar	Apr	May	Jun	Jul	Aug	Sep	Oct	Nov	Dec	Total
Calls for Service	391	380	486	425	526	619	683	668	543	531	501	430	6183
Incidents Filed	92	85	136	133	148	126	132	124	145	137	134	85	1477
Traffic Crash Investigations	18	11	15	12	20	10	9	6	11	13	20	12	157
Number of Persons Arrested	21	28	66	67	80	54	39	55	55	55	60	32	612
Traffic Offenses	22	37	57	60	61	31	38	23	61	49	49	33	521
Miles Traveled	6,970.70	6,669.60	8,063.00	7,408.70	6,896.50	7,153.10	8,564.50	7,843.80	8,130.90	8,662.50	8,335.90	8,300	92,999.20

2020	Jan	Feb	Mar	Apr	May	Jun	Jul	Aug	Sep	Oct	Nov	Dec	Total
Calls for Service	393	393	304	234	374	442	426						2566
Incidents Filed	99	84	89	53	99	121	94	105					744
Traffic Crash Investigations	12	10	4	5	10	9	9	6					65
Number of Persons Arrested	38	35	28	7	29	60	36	26					259
Traffic Offenses	30	25	13	2	15	21	30	17					153
Miles Traveled	8017.9	6772.3	6511.5	5929.4	6937.1	6952.3	6927	5643.8					53691.3

Bazetta Township Police Department

Year to Date Analysis August 2019 Comparison to August 2020

Chief Christopher G. Herlinger

Sgt. Jake Abbott

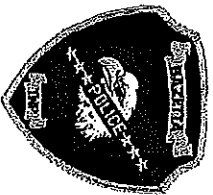

↑↓ Percentage Difference
from 2019 - 2020

	2019	2020	
Calls for Service	668		
Incidents Filed	124	105	-15.323 ↓
Traffic Crash Investigations	6	6	0
Number of Persons Arrested	55	26	-52.727 ↓
Traffic Offenses	23	17	-26.087 ↓
Miles Traveled	7843.80	5643.80	-28.048 ↓

Numbers published as of January 7, 2019 – subject to change Numbers updated on 11/07/2019

LEXIPOL

Lexipol DBA Praetorian Digital

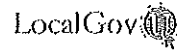
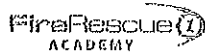
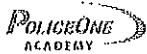

Order Form

Quote Number 00038566

Expiration Date 10/31/2020

Academy Contact Information

Prepared By Margaret Henderson

Email mhenderson@lexipol.com

Phone (415) 962-0196

Department Information

Account Name Bazetta Township Police Department

Payment Type Invoice

Bill To 2671 McCleary Jacoby Rd
Cortland, Ohio 44410
United States

Additional Subscription Terms Any remaining portion of September at no cost.

Contact Name Chris Herlinger

Phone (330) 638-5503

Email cherlinger@bazettatwp.org

10/1/2020 - 12/31/2020 pro-rated \$218.25 due 30 days net.

1/1/2021-12/31/2021 Annual contract w/ the set up \$150 + \$873 = \$1023 invoiced in January 2021

Contract Start Date 10/1/2020

Contract End Date 12/31/2021

Subscription Platform

Product	Additional Details	Quantity	Total Price
Account Services	One time set up fee for 12 users (Discounted - Lexipol Policy)	1.00	USD 150.00
PoliceOne Academy Annual Rate Per User	Annual Subscription for 12 users (Discounted - Lexipol Policy)	12.00	USD 873.00
PoliceOne Academy Annual Rate Per User	Pro-rated Subscription 12 users for 3 months (Discounted - Lexipol Policy)	3.00	USD 218.25
Amount			USD 1,241.25

Terms & Conditions

Billing: A yearly subscription billing period begins at the effective starting date of service as stated above. A payment is due in full at the beginning of the 12-month period unless otherwise specified.

Renewal: Term of subscription will be automatically renewed upon contract end date using current rate card rates at the time of renewal, unless written notice of non-renewal is received at least sixty-days prior to contract end date.

Cancellation: Contract cannot be cancelled prior to effective contract end date. **Department Personnel Use Only:** Passwords and videos can be used by department personnel during the term of the subscription. Sharing department login access to the PoliceOne Academy or CorrectionsOne Academy or any downloaded or video content with other departments is expressly prohibited. Any violation of this policy will result in revocation of department access.

Service Agreement: The terms of this Order Form ("Order Form") and the Master Subscription Agreement ("MSA") located at <https://www.lexipol.com/lms-master-service-agreement/> between the Customer and Praetorian Digital govern the use of the Praetorian Digital Academy learning management system and related services. By executing this Order Form, Customer agrees to the terms of this document and the MSA.

Signature: _____ Date: _____

LEXIPOL

Lexipol DBA Praetorian Digital

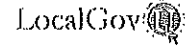

Billing Contact: Ker Thao, kthao@lexipol.com, p: 415.962.8327; F: 415.962.8340;
2611 Internet Blvd Suite 100, Frisco, TX 75034

JED SERVICES

Quote

DATE September 1, 2020

3031 Fallehn Drive
Cortland, OH 44410
330-540-0577

Bill To:

Bazetta Township Police
2671 McCleary Jacoby
Cortland, OH 44410

Prepared by: Joel

330-638-5503

**Notes: Commercial Grade - 3 Year
Warranty on all Hardware.**

Description	AMOUNT
1 - 16 Channel NVR POE	\$ 949.00
2 - 8 TB Purple Hard Drive	\$ 580.00
16 - IP Cameras	\$ 1,904.00
10 outside Junction Boxes	\$ 270.00
Installation, Wiring, Networking, Misc. Set up	\$ 1,650.00
	\$5,353.00

If you have any questions concerning this Invoice, please contact me Joel Davis, 330-540-0577,
joeldavls@neo.rr.com

THANK YOU FOR YOUR BUSINESS!

SOLD TO
 ADDRESS: BAZZETTA TWP
 CITY: _____ STATE: _____ ZIP: _____
 HOME PHONE: _____ JOB PHONE: CHRIS P 330-219-4749

CAMPBELL CARPET, INC.
 246 North High St.
 CORTLAND, OH 44410
 330-637-1871

JOB INVOICE 009648

CONTRACTOR: _____
 SCHEDULED INSTALL DATE: 8/28/20
 SCHEDULED COMPLETION: _____
 CASH CHARGE OTHER: _____

ROOM	MFGR./DISTR	STYLE NO	PRODUCT NAME	COLOR NO	COLOR NAME	TYPE OF FLOORING	WIDTH	LENGTH	TOTAL SQ.YD./FT	PRICE PER SQ.YD./FT	AMOUNT
------	-------------	----------	--------------	----------	------------	------------------	-------	--------	-----------------	---------------------	--------

1 MOHAWK EMERY CARPET
 2 EMERY CARPET
 3 EMERY CARPET

12 x 27 6
 12 x 27 6
 12 x 55 / 73 yd
 1246.84
 NO TAX - 78.84
 \$ 1168.00

TYPE FLOOR: WOOD CEMENT FURNITURE YES NO APPLIANCES YES NO PREP: NO TRACE W/P

SUB-TOTAL 1168
 LABOR 1168
 SALES TAX 78.84
 TOTAL 1246.84

INSTALL DIRECT GLUE

DATE COMPLETED: _____
 PAID IN FULL: _____
 DEPOSIT: _____
 BALANCE DUE: _____

CUSTOMER READ: BEFORE SIGNING: Buyer understands that there may be a dye-lot variation from sample. Seller is not responsible for chips, dents or conditions of existing moldings, doors, jambs or fixtures. Room must be clear of obstacles at time of installation. Seller is not responsible for cutting doors. Seller is not responsible for customers measurements. Seller is not responsible for manufacturer or shipper delays. Unforeseen structural problems upon installation may change the amount due on this invoice. A FINANCE CHARGE OF _____% (_____% PER ANNUM) will be charged to accounts past _____ days. In the event Buyer defaults under the terms of this agreement, Buyer agrees to pay reasonable attorney fees, if the sums due are collected by or through an attorney.

PAYMENT IN FULL TO BE MADE UPON COMPLETION OF INSTALLATION, UNLESS OTHERWISE NOTED.
 BUYER HEREBY ACCEPTS THE ABOVE TERMS AND CONDITIONS. Sig: _____ DATE: _____

Thank you!



INVOICE

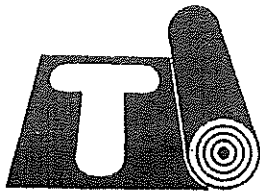

TONDO CARPETS, INC.
1222 Keefer Road • Girard, OH 44420
(330) 539-6014

DATE	8/25/20
PHONE	

CUSTOMER

BAZETTA CEMETERY

YARDAGE

DESCRIPTION OF PURCHASE

BALANCE

2x27 ⁶ 27 ⁶	Estimate Only	
2x55 = 73 ¹ / ₃ YDS		
	GET START PEBBLE	
	GLUE DOWN	12.99
		1319 ⁰⁰
* REPURPOSE @ 17 ⁵⁰	Sale	149 = 1429 ⁰⁰
Old opt is out		

Thank You

TOTAL \$

1 1/2% interest charge on overdue bills
Cash on delivery • Financing is available
25% Restocking fee on returns

2020 Zoning Permits Issued

Date	Permit	Parcel	Owner	Address	Type	Fee
01/18	4152	33-020800	Ann Estenzo	2020 Howland Wilson Rd	Residential Addition	383.50
01/28	4153	31-062885	V.T. Larney LTD	2305 Elm Rd	Sign	96.00
3/17	4153-A		Amendment		Added signage	243.00
02/04	4154	31-025260	Trevor Penn	2980 North ParkExt	Shed >200sf	35.80
02/09	4155	33-076484	Byers T&A	2151 Stonegate Drive	Porch addition	64.00
02/12	4156	31-900532	MPT of Warren Steward LLC	2600 Elm Rd	New Signage Amended Plan	614.82 200.00
3/17	F20-01	31-902103	Cortland BTS Retail	3290 Hoagland Blackstub Rd	Fence	35.00
3/17	4157	33-076448	Storage Zone Ent	2500 Niles Cortland	New Signage	88.50
3/31	F20-02	31-034280	Glancy, Carol	3699 Hoagland Blackstub Rd	Fence	35.00
3/31	4158	33-075907	Cooper, /Tharp	2496 McCleary Jacoby	Pool	113.00
4/10	4159	31-901658	Hatfield, Alex	3204 Deer Trial U-B	Deck fence	49.50
4/21	4160	33-075825	Delacimo, D&K	2500 Uplands	New Residence	858.12
4/21	4161	31-100300	Berry Management	2229 Elm Rd	Commercial Addition	1,250.00
			Sunbelt Rentals			
4/28	F20-03		Joseph Sproviero	2133 Stonegate Dr	Fence	35.00
5/5	4162	33-071900	Barbara Howard	2618 Wilson Sharpville	Garage attached	100.00
5/5	4163	33-075972	Bandon Kirk	2060 Timber Creek	Pool, 27' above	143.00
5/5	4164	33-076178	Brown J&D	2251 Howland Wilson	Garage addition	77.00
5/12	4165	33-051175	Serotko	2544 McCleary Jacoby	Shed	20.00
5/12	4166	33-075347	Divieste, Joe	2209 McCleary Jacoby	New Garage	375.00
		DM-01			Demo-old	50.00
5/12	DM-02	31-017080	TC Land Riut	3238 North Park	Demo	50.00
5/11	F20-04	33-076591	Delulio, R&L	2558 North View	Fence	35.00
5/19	4167	33-076329	Waid, Mark and Amy	2011 Niles Cortland Rd	Garage addition att	600.00
5/19	4168	31-092100	Beardsley, Shawn	3714 Hoagland Blackstub rd	Deck	120.00
5/26	4169	33-030421	Parks, Jones	3473 SR 5	Sign	100.00
5/26	4170	33-076052	McCelland, David and Cheryle	2024 Red Fox m	Shed	30.00
5/26	4171	33-076469	Bowman	2128 Stonegate	Pool	150.00
6/02	4172	33-076106	Rich, Mark & Erin	2888 Beaver Trail	Pool	143.00
		4172-A			Pool deck (add)	81.25
6/02	4173	33-076336	Bertuzzi, Frank & Kelly	2583 Niles Cortland Rd	Garage	180.00
06/03	\D-080		Wright, john	4001 Lakeshore	Dumpster	5.00

2020 Zoning Permits Issued

Permit Date	Permit Number	Applicant	Property Address	Structure / Use	Value
06/09	4174	Redman, Bruce	4394 Durst Clagg Rd	Agg Building	EXEMPT
06/09	4175	Bowser, Kleth	1920 Quail Run	Pool above	143.00
06/15	F20-04	Caughney, Roy	3295 Niles Cortland Rd	Fence	35.00
06/09	4176	Dejulio	2558 North View Dr	Shed	54.00
06/09	4177	English, Anthony / lisa	2284 Keystone	Pool	162.00
	4178			Garage	300.00
06/16	4179	Ashburn, Joseph	2015 Deer Creek Run	Pool AG 27R	143.00
06/16	4180	Fedales, M&B	1372 Millers Landing	Garage Un-Attached	300.00
06/17	4181	Ulrich, Miles / Linda	3363 Warren Meadville Rd	Accessory Building	180.00
06/19	4182	Serotko, David	2544 McCleary Jacoby Rd	Pool	113.00
07/07	4183	Raymond, Shane	2467 Howland Wilson Rd	Deck	192.00
06/13	F20-05	Motika, Susan	2270 Wilson Sharpville	Fence	35.00
07/14	4184	Gee / Hoke Taylor	3159 Ivey Hill Cir Unit A	Deck	36.00
07/28	4185	Turbok, Billie jo	3898 Durst Clagg Rd	Shed	25.00
07/28	4186	Caires, Heidi / David	4598 Phillips Rice Rd	Pool	143.00
07/28	F20-06	Sharp, Jenna	3920 Lakeshore Dr	Fence	35.00
8/18	4187	Matheny C/R	3924 North Park Ave	Garage	192.00
8/25	F20-07	Byers, Tim / Annamarie	2151 Stone Gate Dr	Fence	35.00
8/25	4188	Cortland Trinity Baptist Church	2576 McCleary Jacoby Rd	Sign	48.00
8/25	4189	Dibell Mark / Leslie	2920 Warren Meadville rd	Residential Addition	56.00
8/25	4190	Trumick Charles / Pamela	2763 McCleary Jacoby Rd	Garage	120.00
9/1	4191	Crevier, R&B	4220 N. Park	Shed	84.00