

BAZETTA TOWNSHIP TRUSTEES

REGULAR MEETING MINUTES

Date: May 25, 2021 @ 7:00 pm
Bazetta Township Administration Building
3372 State Route 5, N.E.
Cortland, Ohio 44410

Present:

Chairman Trustee Ted Webb - H
Vice Chairman Trustee Bob McBride - H
Trustee Frank Parke - H
Fiscal Officer Stacy Marling - H

Trustee Webb opened the meeting with the Pledge of Allegiance and a moment of silence.

Trustee McBride reminded the assemblage of the Public Comments Procedure and that the meeting is being video and audio recorded for informational purposes.

119-21 Resolution accepting the meeting minutes from the May 11th meeting and the May 21st special meeting.

Motion: Trustee P

Second: Trustee W

Vote: Trustee McBride ABSTAIN Trustee Parke Y Trustee Webb Y

CORRESPONDENCE (COPIES AVAILABLE UPON REQUEST):

- Trustee Webb attended the Board of Directors COG Meeting

ADMINISTRATION:

120-21 Resolution to authorize the Fiscal Officer to revise the 2021 Appropriations. Appropriation Supplemental to increase for estimated expenditures for 2021 as listed:

Fund 1000	Increase	\$ 61,250
Fund 2011	Increase	2,500
Fund 2021	Increase	132,000
Fund 2031	Increase	230,596
Fund 2041	Increase	3,541
Fund 2081	Increase	87,450
Fund 2082	Increase	57,643
Fund 2111	Increase	45,435

Motion: Trustee M

Second: Trustee P

Vote: Trustee McBride Y Trustee Parke Y Trustee Webb Y

121-21

Resolution declaring it to be necessary to levy a tax outside the 10 mill limitation for the purpose of Fire Protection and EMS Service within the township, to renew the current 0.8 mill Fire/EMS levy that expires for collection, December 31, 2021.

(See attachment)

Motion: Trustee M

Second: Trustee P

Vote: Trustee McBride Y Trustee Parke Y Trustee Webb Y

FIRE DEPARTMENT:

- Nothing to report

POLICE DEPARTMENT:

122-21

Resolution to approve the attached Mahoning/Columbiana/Trumbull County Local Government Mutual Aid Agreement for Law Enforcement. **(See attachment)**

Motion: Trustee P

Second: Trustee M

Vote: Trustee McBride Y Trustee Parke Y Trustee Webb Y

123-21

Resolution to accept the attached Quote Ticket #331209 from Micro Doctor IT for an update to Office 365 for all police department employees. This will allow an update to services without an added cost of a replacement server, as the police department current one is out of service. The cost is \$12.50/person for 12 employees for a cost of \$150.00/month to be paid from equipment fund 2082-210-420-0000. We are currently paying \$4.00/employee for email only access. **(See attachment)**

Motion: Trustee M

Second: Trustee P

Vote: Trustee McBride Y Trustee Parke Y Trustee Webb Y

ROAD DEPARTMENT:

124-21

Resolution to purchase a 2021 or 2022 Freightliner Truck Chassis from Fyda Freightliner Youngstown for a price of \$83,250.00. **(See attachment)**

Motion: Trustee P

Second: Trustee M

Vote: Trustee McBride Y Trustee Parke Y Trustee Webb Y

ZONING:

125-21

Resolution to approve the Abatement of Weeds and Grass only 505.87 (B) O.R.C. for the properties listed. Not to exceed \$5,000 for Abatement Program. **(See attached)**

- 2369 Bianca Lane (Parcel #33-076303)
- 4362 Hoagland Blackstub Road (Parcel #33-066300)
- 3384 Durst Clagg Road (Parcel #33-035726)
- 3223 Durst Clagg Road (Parcel #31-08480)

Motion: Trustee M
Second: Trustee P
Vote: Trustee McBride Y Trustee Parke Y Trustee Webb Y

PLANNING DIRECTOR, ZONING INSPECTOR AND CODE ENFORCEMENT OFFICER:

ZONING COMMISSION AND ZONING BOARD OF APPEALS:

- Discussion on what took place at the meeting

PARKS AND RECREATION BOARD:

ASKED TO BE PLACED ON THE AGENDA:

PUBLIC COMMENT:

- Cheryl Tennant, 1061 Perkins Jones Road,
 - Thanked the police department for staying with her grandson after an accident until the tow truck arrived
 - Stated that per ORC 50702 Cyndi Chapman is not allowed to be a Deputy Fiscal Officer. She can be the Fiscal Officer Assistant

126-21 Resolution to adjourn the meeting at 7:24 pm.

Motion: Trustee P
Second: Trustee M
Vote: Trustee McBride Y Trustee Parke Y Trustee Webb Y

Attested by:

Ted Webb

Approved by: Chairman Trustee Ted Webb

Date

6/8/21

Date

Bazetta Township 0.8 mill Renewal Fire Levy General 2021

**RESOLUTION DECLARING IT NECESSARY TO LEVY A
TAX IN EXCESS OF THE TEN MILL LIMITATION**

RESOLUTION No.: # 121 -21 (Renewal Fire Tax Levy 0.8 Mills)

The Board of Trustees of Bazetta Township, Trumbull County, Ohio, met in regular session on the 25th day of May, 2021, at the office of said Board, with the following members present:

Trustee	Theodore Webb
Trustee	Frank Parke
Trustee	Robert McBride

Trustee McBride moved the adoption of the following Resolution:

WHEREAS, the amount of taxes which may be raised within the ten mill limitation will be insufficient to provide an adequate amount for the necessary requirements of said Bazetta Township, Trumbull County, Ohio; and

WHEREAS, a resolution declaring the necessity of levying a tax under RC §505.37(A) RC §5705.03, RC §5705.19(I) and RC §5705.191 outside the ten mill limitation must be passed and certified to the County Auditor in order to permit the Board to consider the levy of such a tax and must request that the County Auditor certify to the Board of Trustees the total current tax valuation of Bazetta Township and the dollar amount of revenue that would be generated by the tax; therefore be it

RESOLVED, by the Board of Trustees of Bazetta Township, Trumbull County, Ohio, all members elected thereto concurring, that it is necessary to levy a renewal tax in excess of the ten mill limitation for the benefit of Bazetta Township, pursuant to RC §505.37(A), §5705.03, RC §5705.19(I) and RC §5705.191 for the

purpose of providing and maintaining fire apparatus, appliances, buildings, or sites therefore, or sources of water supply and materials therefore, or the establishment and maintenance of lines of fire alarm telegraph, or the payment of permanent, part-time or volunteer firefighters personnel or fire fighting companies to operate the same, including the payment of firefighter employer's contributions required under RC §742.34 of the Ohio Revised Code or to purchase ambulance equipment, or to provide ambulance, paramedic or other emergency medical services operated by a fire department or fire fighting company, at a rate not exceeding 0.8 mills for each one dollar of valuation, which amounts to \$0.08 for each one hundred dollars of valuation for a period of five (5) years, commencing tax year 2021 collection year beginning 2022, which tax will be voted upon and levied on the total unincorporated area of Bazetta Township, which is wholly located in Trumbull County, Ohio.

BE IT FURTHER RESOLVED that the Fiscal Officer Certify a copy of this Resolution to the County Auditor for certification of the total tax valuation of Bazetta Township and the dollar amount of Revenue to be generated by the tax;

BE IT FURTHER RESOLVED upon certification of the County Auditor that the provisions of said tax levy be submitted to the electors of said Bazetta Township, in the general election to be held on the 2nd day of November , 2021; and

BE IT FURTHER RESOLVED that said tax levy be submitted to the electors under the authority of Ohio Revised Code, Sections §505.37(A), §5705.03, §5705.19(I) and §5705.191.; and

BE IT FURTHER RESOLVED that the Fiscal Officer of the Board of Trustees of Bazetta Township be and is hereby directed to

Bazetta Township 0.8 mill Renewal Fire Levy General 2021

certify a copy of this Resolution to the Board of Elections, Trumbull County, Ohio, not less than ninety days prior to the election and notify said Board of Elections to cause notice of election on the question of levying said tax to be given as required by law.

Trustee Parke seconded the Motion and the roll being called upon its adoption the vote resulted as follows:

Trustee McBride	Yes
Trustee Parke	Yes
Trustee Webb	Yes

Adopted the 25th day of May, 2020.

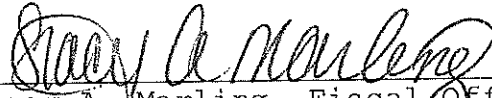

Stacy A. Marling, Fiscal Officer

CERTIFICATION

I, the undersigned Fiscal Officer of Bazetta Township certify that the foregoing is a true and accurate copy of the Resolution of the Bazetta Township Board of Trustees, as appears in the minutes of the transcript of the Official Proceedings of the Bazetta Township Board of Trustees.

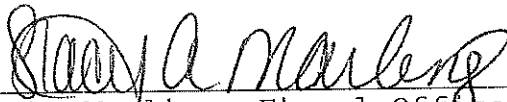

Stacy A. Marling, Fiscal Officer

Date: 5/25/21

Prepared by: Mark S. Finamore, Esq.
Turner May & Shepherd
Township Special Legal Counsel

**MAHONING/COLUMBIANA/TRUMBULL COUNTY LOCAL GOVERNMENT
MUTUAL AID AGREEMENT FOR LAW ENFORCEMENT**

THE UNDERSIGNED local governments and law enforcement agencies (hereinafter the Agency or Agencies) in Mahoning, Columbiana, and Trumbull Counties, Ohio, have entered this mutual aid agreement pursuant to Sections 505.431, 737.041, and 3345.041 of the Revised Code and pursuant to any other applicable local government authority including home-rule. This agreement has been executed for the purpose of providing reciprocal police services across jurisdictional lines to enhance the capabilities of law enforcement to protect citizens and property throughout Mahoning, Columbiana, and Trumbull Counties. Each undersigned local government Agency acknowledges the adoption of and shall provide a certified copy of a resolution by the appropriate legislative authority authorizing the terms of this agreement, authorizing the provision of police services to any other Agency pursuant to the terms of Section 505.431, 737.041 and 3345.041 of the Ohio Revised Code and authorizing those police department members acting outside of their jurisdiction to exercise full police authority within the jurisdiction of any other Agency who is participating in this Agreement.

The undersigned Agencies shall provide and exchange the full array of police services to and from any of the other Agencies without limitation but generally in accord with the following guidelines.

I. COOPERATIVE ENFORCEMENT WITHOUT REQUEST

The Agencies recognize related criminal activities routinely occur across jurisdictional lines and that cooperation between Agencies can increase the effectiveness of law enforcement throughout Mahoning, Columbiana, and Trumbull County. Any Agency may proceed without request from a cooperating Agency generally according to the following guidelines:

A. In-Progress Crime Assistance Without Request

Whenever an on-duty law enforcement officer from one jurisdiction views or otherwise has probable cause to believe a criminal offense has occurred outside the

officer's home jurisdiction but within the jurisdiction of a cooperating Agency, the officer may make arrests according to law and take any measures necessary to preserve the crime scene. Control of any arrested person, evidence and the crime scene shall be relinquished to the first available officer from the jurisdiction within which the crime took place. The arresting officer may immediately transport or relocate any arrested persons or evidence if the officer determines that remaining at the crime scene could endanger himself or others or threaten the preservation of any evidence.

II. INVESTIGATION OUTSIDE ORIGINAL JURISDICTION

On-duty officers from one Agency may, without request or prior notice, continue to conduct investigations that originate within their home jurisdiction into the jurisdiction of any cooperating Agency. If enforcement action is anticipated, the location and nature of the investigation will be reported to the appropriate cooperating Agency. Subsequent arrests, search warrant service or similar police actions will be coordinated with the affected Agency.

III. INDEPENDENT POLICE ACTION

The police department of any cooperating Agency may provide police protection service to any other cooperating Agency. Each cooperating Agency that is a party to this contract shall provide a certified copy of a resolution adopted by the appropriate legislative authority that authorized both the provision and receipt of such services by each cooperating Agency. Such certified copies shall be kept on file with the original of this contract in a location to be agreed upon by the Agencies.

IV. OPERATION ASSISTANCE UPON REQUEST

The Agencies recognize that special public safety incidents occasionally occur that require the services of additional law enforcement personnel. Such additional services may be provided by or to any cooperating Agency, generally according to the following guidelines:

A. Dangerous Criminal Activity

Whenever one Agency reports criminal activity and that Agency is unable to provide the immediate response necessary to prevent death, serious physical harm or substantial property loss as a result of said criminal activity, that Agency may request police assistance services of any nature from any other Agency.

B. Searches for Fugitive or Wanted Persons

When one Agency is conducting a search for a fugitive person whose presence is reasonably believed to be within the Agency jurisdiction and immediate police assistance is reasonably necessary to apprehend or prevent the escape of the fugitive or to protect the safety of persons and property from imminent danger related to said fugitive, that Agency may request police assistance services from any other Agency.

C. Traffic Control Assistance

Where an incident occurs on or near a roadway creating the imminent danger of a traffic accident, assistance from a cooperating Agency may be provided upon request of the affected jurisdiction.

V. GENERAL POLICE SERVICE

A. Any incident may form the basis for the request of police protection services from one or more cooperating Agencies to another when police assistance is reasonably necessary to protect the safety of persons and property.

B. Police services assistance including routine patrol services may be requested and supplied by cooperating Agencies for special events or other circumstances over extended periods.

VI. GENERAL TERMS AND PROCEDURES

A. A request for police services assistance will be made by the commander of the law enforcement Agency, or his designee. The designee must be of a supervisory rank, or the senior shift officer, when no supervisor is present.

B. A cooperating Agency will provide police services assistance only to the extent that the personnel and equipment are not required for the adequate protection of that Agency's jurisdiction. The commander of the law enforcement Agency, or his designee, will have the sole authority to determine the amount of personnel and

equipment, if any, available for assistance. There shall be no liability, responsibility or cause of action between or among the parties if assistance is denied, delayed, inadequate, or subsequently recalled, or if furnished assistance is not needed upon arrival.

C. Whenever the law enforcement employees of one cooperating Agency are providing police services in or to another cooperating agency pursuant to the authority contained in this agreement, other legislative authority or state law, such employees will have the same power, duties, rights and immunities as if taking action within the territory of their employing Agency, subject to the terms of this agreement.

D. Whenever the law enforcement employees of one cooperating Agency are providing police services upon request to another cooperating Agency, they will be under the lawful direction and authority of the commanding law enforcement officer of the Agency to which they are rendering assistance. Officers shall be subject to the code of ethics, policies and rules and regulations of their employing Agency at all times.

E. Police services assistance can be initiated by any on-duty officer who has probable cause to believe a crime is in progress. Such police services assistance can also be initiated by any on-duty officer who becomes aware of a traffic accident, the need for traffic control, a suspected DUI, a serious traffic violation or other circumstance requiring law enforcement intervention in another cooperating Agency jurisdiction. The officer must contact his immediate supervisor to enable that supervisor to authorize and direct actions taken by the officer.

F. An on-duty officer initiating police services assistance will notify a law enforcement officer from the affected cooperating Agency as soon as possible. The assisted cooperating Agency will relieve the officer as soon as possible when appropriate.

G. All wage and disability payments, pension, worker's compensation claims, medical expenses or other employment benefits will be the responsibility of the employing Agency, unless the requesting Agency is reimbursed for such costs from any other source. Each Agency shall be responsible for the negligence of its employees to the extent specified by law. The local law enforcement Agencies which are parties to this Agreement will not indemnify and hold harmless any Agency participating in this Agreement for any damages awarded by the Court or Claims in any civil action arising

from any action or omission of any officer of any Agency participating in this Agreement pursuant to this Agreement.

H. Each cooperating Agency shall be responsible for any costs arising from the loss of or damage to the Agency's equipment or property while providing police assistance services within any other cooperating Agency.

I. Any Agency may revoke its future obligations hereunder only upon sixty (60) days written notice to each of the other cooperating Agencies by registered mail.

J. Personnel of the Agency acting under this agreement outside of the Agency's jurisdiction may participate in any pension or indemnity fund established by their Agency to the same extent as if they were acting within their jurisdiction, and are entitled to all rights and benefits under ORC4123.01 to ORC4123.94 the same as if they were performing police services within their jurisdiction.

VII. LIST OF COOPERATING AGENCIES

AGENCY: BAZETTA TOWNSHIP POLICE DEPARTMENT

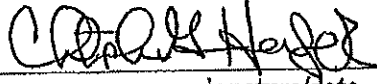
AUTHORIZED OFFICIAL:  5/19/2021
signature/date

PRINT NAME AND TITLE: CHRISTOPHER G. HERLINGER

CHIEF OF POLICE

Fw: Completed: Microdoctor Service Ticket #331209/ Quote for Office 365 License Upgrade

Joel Davis <jdavis@bazettatwp.org>

Mon 5/24/2021 7:07 AM

To: Chris Herlinger <cherlinger@bazettatwp.org>

Hi Chris - Upgrade to Microsoft Office Business Standard is 12.50 per month per user. you are already paying 4.00 per month for essentials which includes your email.

From: Support Microdoctor <Support@microdoctor.com>
Sent: Friday, May 21, 2021 1:43 PM
To: Joel Davis <jdavis@bazettatwp.org>
Subject: Completed: Microdoctor Service Ticket #331209/ Quote for Office 365 License Upgrade

--REPLY above this line to respond--

Contact Us

Customer Portal

Remote Support

Joel Davis at Bazetta Township:

Your Issue: Quote for Office 365 License Upgrade, is In our system as Ticket #331209, . This ticket status has been changed to Completed*. Our Technician has completed their assigned tasks on this service ticket.

Full ticket details

Ticket #331209

Ticket: Quote for Office 365 License Upgrade

Status: Completed*

Company: Bazetta Township

Contact: Joel Davis

Phone: (330) 540-0577

Address: 3372 State Route 5 NE
Cortland, OH 44410

Discussion:

Thu 5/20/2021/12:35 PM UTC-04/ Dustin Drvodelic-

Joel was wanting a quote for upgrading to Business Standard licenses - through Pax8 - License needs to include sharepoint

Thu 5/20/2021/12:45 PM UTC-04/ Joel Davis jdavis@bazettatwp.org

Hi Bill -- need to get a cost to upgrade 12 users on bazetta's account to have 365 including word,excel, sharepoint, etc.

Currently they have essentials I think at \$4.00 per month per user

Would that just be upgrade to the license and I was think around another \$8.00 or so a total per user is \$12.00 or 12.50

Just wanting to verify and how quick can this happen once approved?

Joel
330-540-0577

Thu 5/20/2021/1:05 PM UTC-04/ Bill Wittman (time)-
Business Standard \$12.50 per user per month
<https://www.microsoft.com/en-us/micros...>
Provisioning the licenses - 10 minutes
Assigned the licenses to the 12 users - 10 minutes.
Remove unnecessary licenses - 10 minutes
We can do all that no charge.
Let me know.

Fri 5/21/2021/1:40 PM UTC-04/ Joel Davis jdavis@bazettatwp.org
Bill - thank you. Will advise
Joel

Get [Outlook for iOS](#)

Fri 5/21/2021/1:45 PM UTC-04/ Bill Wittman (time)-
If the quote is accepted then a new ticket can be created.
Completing this ticket.
If the quote is accepted then a new ticket can be created.
Completing this ticket.
Thank you in advance for your assistance and cooperation. Our goal is to provide you with **world-class support**.
We would appreciate any feedback on how we are doing.

Your Technology Support Team
Note: Some issues require us to remotely access your workstation and/or server.
To go directly to this ticket, click [here](#).

 **Need help now?**
MDI-911
Escalation

We do offer immediate escalation!
Contact us for more details at: 330-898-2100

Service Agreements 

Our Service Agreements offer **GUARANTEED** response times, and pro-active maintenance. If you are interested in learning more about our agreements, please contact the sales team by phone: 330-898-2100 option 1 or email: info@microdoctor.com

4195 Parkman Road | Warren, OH 44481 | © Micro Doctor, IT All Rights Reserved.

Resource Scheduling:

Done: Yes
Member: Bill Wittman
Hours: 0.00
Status: Tentative
Start: 05/22/2021
Finish: 05/22/2021

Prepared for:
KRIS PARKE
BAZETTA TOWNSHIP
3372 ST RT 5
CORTLAND, OH 44410
Phone: 330-219-4749

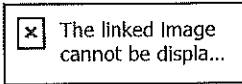

Prepared by:
Ron Knight
FYDA FREIGHTLINER
YOUNGSTOWN
5260 SEVENTY-SIX DR.
YOUNGSTOWN, OH 44515
Phone: 330-797-0224

A proposal for
BAZETTA TOWNSHIP

Prepared by
FYDA FREIGHTLINER YOUNGSTOWN
Ron Knight

May 17, 2021

Freightliner 108SD

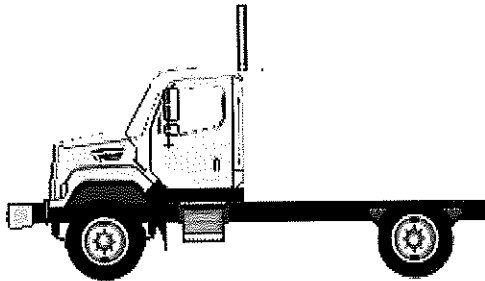

Components shown may not reflect all spec'd options and are not to scale

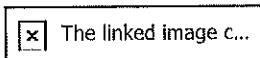

Prepared for:
 KRIS PARKE
 BAZETTA TOWNSHIP
 3372 ST RT 5
 CORTLAND, OH 44410
 Phone: 330-219-4749

 The linked image cannot be displa...

Prepared by:
 Ron Knight
 FYDA FREIGHTLINER
 YOUNGSTOWN
 5260 SEVENTY-SIX DR.
 YOUNGSTOWN, OH 44515
 Phone: 330-797-0224

S P E C I F I C A T I O N P R O P O S A L

Data Code	Description	Weight Front	Weight Rear
Price Level			
PRL-23D	SD PRL-23D (EFF:01/21/20)		
Data Version			
DRL-005	SPECPRO21 DATA RELEASE VER 005		
Interior Convenience/Driver Retention Package			
055-004	INTERIOR CONVENIENCE PACKAGE WITH CB PROVISION		
Vehicle Configuration			
001-176	108SD CONVENTIONAL CHASSIS	6,829	3,748
004-222	2022 MODEL YEAR SPECIFIED		
002-004	SET BACK AXLE - TRUCK		
019-001	TRAILER TOWING PROVISION AT END OF FRAME FOR TRUCK	10	10
003-001	LH PRIMARY STEERING LOCATION		
General Service			
AA1-003	TRUCK/TRAILER CONFIGURATION		
AA6-001	DOMICILED, USA 50 STATES (INCLUDING CALIFORNIA AND CARB OPT-IN STATES)		
A85-011	CONSTRUCTION SERVICE		
A84-1GM	GOVERNMENT BUSINESS SEGMENT		
AA4-010	DIRT/SAND/ROCK COMMODITY		
AA5-002	TERRAIN/DUTY: 100% (ALL) OF THE TIME, IN TRANSIT, IS SPENT ON PAVED ROADS		
AB1-008	MAXIMUM 8% EXPECTED GRADE		
AB5-001	SMOOTH CONCRETE OR ASPHALT PAVEMENT - MOST SEVERE IN-TRANSIT (BETWEEN SITES) ROAD SURFACE		
995-1A0	FREIGHTLINER SD VOCATIONAL WARRANTY		
A66-99D	EXPECTED FRONT AXLE(S) LOAD : 16000.0 lbs		
A68-99D	EXPECTED REAR DRIVE AXLE(S) LOAD : 23000.0 lbs		
A63-99D	EXPECTED GROSS VEHICLE WEIGHT CAPACITY : 39000.0 lbs		

 The linked image c...

Prepared for:
 KRIS PARKE
 BAZETTA TOWNSHIP
 3372 ST RT 5
 CORTLAND, OH 44410
 Phone: 330-219-4749

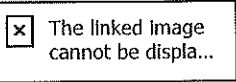

Prepared by:
 Ron Knight
 FYDA FREIGHTLINER
 YOUNGSTOWN
 5260 SEVENTY-SIX DR.
 YOUNGSTOWN, OH 44515
 Phone: 330-797-0224

Data Code	Description	Weight Front	Weight Rear
A70-99D	EXPECTED GROSS COMBINATION WEIGHT : 80000.0 lbs		
Truck Service			
AA3-018	FRONT PLOW/END DUMP BODY		
AF3-2BJ	UNIVERSAL TRUCK BODY		
Tractor Service			
AA2-005	FLATBED TRAILER		
AH6-001	SINGLE (1) TRAILER		
Engine			
101-3BP	CUM L9 330 HP @ 2200 RPM; 2200 GOV RPM, 1000 LB-FT @ 1200 RPM		
Electronic Parameters			
79A-065	65 MPH ROAD SPEED LIMIT		
79B-000	CRUISE CONTROL SPEED LIMIT SAME AS ROAD SPEED LIMIT		
80J-002	REGEN INHIBIT SPEED THRESHOLD - 5 MPH		
Engine Equipment			
99C-021	2016 ONBOARD DIAGNOSTICS/2010 EPA/CARB/GHG21 CONFIGURATION		
99D-011	2008 CARB EMISSION CERTIFICATION - CLEAN IDLE (INCLUDES 6X4 INCH LABEL ON LOWER FORWARD CORNER OF DRIVER DOOR)		
13E-001	STANDARD OIL PAN		
105-001	ENGINE MOUNTED OIL CHECK AND FILL		
014-1C5	SIDE OF HOOD AIR INTAKE WITH FIREWALL MOUNTED DONALDSON AIR CLEANER AND INSIDE/OUTSIDE AIR WITH SNOW DOOR	10	
124-1D7	DR 12V 160 AMP 28-SI QUADRAMOUNT PAD ALTERNATOR WITH REMOTE BATTERY VOLT SENSE		
292-235	(2) DTNA GENUINE, FLOODED STARTING, MIN 2000CCA, 370RC, THREADED STUD BATTERIES		
290-017	BATTERY BOX FRAME MOUNTED		
281-001	STANDARD BATTERY JUMPERS		
282-001	SINGLE BATTERY BOX FRAME MOUNTED LH SIDE UNDER CAB		
291-017	WIRE GROUND RETURN FOR BATTERY CABLES WITH ADDITIONAL FRAME GROUND RETURN		
289-001	NON-POLISHED BATTERY BOX COVER		
87P-001	CAB AUXILIARY POWER CABLE	5	

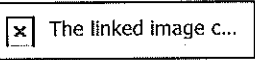

Prepared for:
 KRIS PARKE
 BAZETTA TOWNSHIP
 3372 ST RT 5
 CORTLAND, OH 44410
 Phone: 330-219-4749

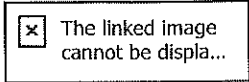

Prepared by:
 Ron Knight
 FYDA FREIGHTLINER
 YOUNGSTOWN
 5260 SEVENTY-SIX DR.
 YOUNGSTOWN, OH 44515
 Phone: 330-797-0224

Data Code	Description	Weight Front	Weight Rear
293-058	POSITIVE LOAD DISCONNECT WITH CAB MOUNTED CONTROL SWITCH MOUNTED OUTBOARD DRIVER SEAT	8	
295-029	POSITIVE AND NEGATIVE POSTS FOR JUMPSTART LOCATED ON FRAME NEXT TO STARTER	2	
107-032	CUMMINS TURBOCHARGED 18.7 CFM AIR COMPRESSOR WITH INTERNAL SAFETY VALVE		
152-041	ELECTRONIC ENGINE INTEGRAL SHUTDOWN PROTECTION SYSTEM		
128-076	CUMMINS ENGINE INTEGRAL BRAKE WITH VARIABLE GEOMETRY TURBO ON/OFF	20	
016-1C2	RH OUTBOARD UNDER STEP MOUNTED HORIZONTAL AFTERTREATMENT SYSTEM ASSEMBLY WITH RH B-PILLAR MOUNTED VERTICAL TAILPIPE	30	25
28F-002	ENGINE AFTERTREATMENT DEVICE, AUTOMATIC OVER THE ROAD REGENERATION AND DASH MOUNTED REGENERATION REQUEST SWITCH		
* 239-200	INTEGRATED STACK AND B-PILLAR PIPE WITH MINIMUM STACK PROTRUSION ABOVE CAB		
237-1CR	RH CURVED VERTICAL TAILPIPE B-PILLAR MOUNTED ROUTED FROM STEP		
23U-001	6 GALLON DIESEL EXHAUST FLUID TANK	-35	-10
30N-003	100 PERCENT DIESEL EXHAUST FLUID FILL		
23Y-001	STANDARD DIESEL EXHAUST FLUID PUMP MOUNTING		
43X-002	LH MEDIUM DUTY STANDARD DIESEL EXHAUST FLUID TANK LOCATION		
43Y-001	STANDARD DIESEL EXHAUST FLUID TANK CAP		
242-001	STAINLESS STEEL AFTERTREATMENT DEVICE/MUFFLER/TAILOPIPE SHIELD		
273-018	HORTON DRIVEMASTER ADVANTAGE ON/OFF FAN DRIVE		
276-002	AUTOMATIC FAN CONTROL WITH DASH SWITCH AND INDICATOR LIGHT, NONENGINE MOUNTED		
110-003	CUMMINS SPIN ON FUEL FILTER		
118-008	COMBINATION FULL FLOW/BYPASS OIL FILTER		
266-104	1115 SQUARE INCH ALUMINUM RADIATOR		
103-039	ANTIFREEZE TO -34F, OAT (NITRITE AND SILICATE FREE) EXTENDED LIFE COOLANT		
171-007	GATES BLUE STRIPE COOLANT HOSES OR EQUIVALENT		

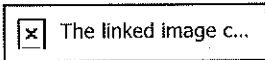

Prepared for:
 KRIS PARKE
 BAZETTA TOWNSHIP
 3372 ST RT 5
 CORTLAND, OH 44410
 Phone: 330-219-4749

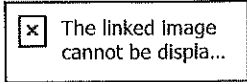

Prepared by:
 Ron Knight
 FYDA FREIGHTLINER
 YOUNGSTOWN
 5260 SEVENTY-SIX DR.
 YOUNGSTOWN, OH 44515
 Phone: 330-797-0224

Data Code	Description	Weight Front	Weight Rear
172-001	CONSTANT TENSION HOSE CLAMPS FOR COOLANT HOSES		
270-016	RADIATOR DRAIN VALVE		
138-011	PHILLIPS-TEMRO 1000 WATT/115 VOLT BLOCK HEATER	4	
140-022	CHROME ENGINE HEATER RECEPTACLE MOUNTED UNDER LH DOOR		
132-004	ELECTRIC GRID AIR INTAKE WARMER		
155-058	DELCO 12V 38MT HD STARTER WITH INTEGRATED MAGNETIC SWITCH		

Transmission

342-582	ALLISON 3000 RDS AUTOMATIC TRANSMISSION WITH PTO PROVISION
---------	--

Transmission Equipment

343-314	ALLISON VOCATIONAL PACKAGE 146 - AVAILABLE ON 3000/4000 PRODUCT FAMILIES WITH VOCATIONAL MODEL RDS
84B-012	ALLISON VOCATIONAL RATING FOR ON/OFF HIGHWAY APPLICATIONS AVAILABLE WITH ALL PRODUCT FAMILIES
84C-023	PRIMARY MODE GEARS, LOWEST GEAR 1, START GEAR 1, HIGHEST GEAR 6, AVAILABLE FOR 3000/4000 PRODUCT FAMILIES ONLY
84D-023	SECONDARY MODE GEARS, LOWEST GEAR 1, START GEAR 1, HIGHEST GEAR 6, AVAILABLE FOR 3000/4000 PRODUCT FAMILIES ONLY
84E-000	PRIMARY SHIFT SCHEDULE RECOMMENDED BY DTNA AND ALLISON, THIS DEFINED BY ENGINE AND VOCATIONAL USAGE
84F-000	SECONDARY SHIFT SCHEDULE RECOMMENDED BY DTNA AND ALLISON, THIS DEFINED BY ENGINE AND VOCATIONAL USAGE
84G-000	PRIMARY SHIFT SPEED RECOMMENDED BY DTNA AND ALLISON, THIS DEFINED BY ENGINE AND VOCATIONAL USAGE
84H-000	SECONDARY SHIFT SPEED RECOMMENDED BY DTNA AND ALLISON, THIS DEFINED BY ENGINE AND VOCATIONAL USAGE
84N-200	FUEL SENSE 2.0 DISABLED - PERFORMANCE - TABLE BASED
84U-000	DRIVER SWITCH INPUT - DEFAULT - NO SWITCHES
84V-001	DIRECTION CHANGE ENABLED WITH MULTIPLEXED SERVICE BRAKES - ALLISON 5TH GEN TRANSMISSIONS



Prepared for:
 KRIS PARKE
 BAZETTA TOWNSHIP
 3372 ST RT 5
 CORTLAND, OH 44410
 Phone: 330-219-4749

 The linked image cannot be displa...

Prepared by:
 Ron Knight
 FYDA FREIGHTLINER
 YOUNGSTOWN
 5260 SEVENTY-SIX DR.
 YOUNGSTOWN, OH 44515
 Phone: 330-797-0224

Data Code	Description	Weight Front	Weight Rear
85E-043	MAXIMUM ENGINE SPEED FOR PTO ENGAGEMENT 2600 RPM		
85F-054	MAXIMUM ENGINE SPEED FOR PTO OPERATION 3000 RPM		
85G-119	MAXIMUM OUTPUT SPEED FOR PTO ENGAGEMENT 3000 RPM - ALLISON 5TH GEN TRANSMISSIONS		
85H-119	MAXIMUM OUTPUT SPEED FOR PTO OPERATION 3000 RPM - ALLISON 5TH GEN TRANSMISSIONS		
353-067	VEHICLE INTERFACE WIRING CONNECTOR WITH PDM AND BLUNT CUTS, AT BACK OF CAB		
34C-001	ELECTRONIC TRANSMISSION CUSTOMER ACCESS CONNECTOR FIREWALL MOUNTED		
362-823	CUSTOMER INSTALLED CHELSEA 280 SERIES PTO		
363-001	PTO MOUNTING, LH SIDE OF MAIN TRANSMISSION		
341-018	MAGNETIC PLUGS, ENGINE DRAIN, TRANSMISSION DRAIN, AXLE(S) FILL AND DRAIN		
345-003	PUSH BUTTON ELECTRONIC SHIFT CONTROL, DASH MOUNTED		
97G-004	TRANSMISSION PROGNOSTICS - ENABLED 2013		
370-015	WATER TO OIL TRANSMISSION COOLER, IN RADIATOR END TANK		
346-013	TRANSMISSION OIL CHECK AND FILL WITH CROSSOVER TO CLEAR LH PTO AND DIRECT MOUNT PUMP		
35T-001	SYNTHETIC TRANSMISSION FLUID (TES-295 COMPLIANT)		

Front Axle and Equipment

400-1A9	DETROIT DA-F-16.0-5 16,000# FL1 71.0 KPI/3.74 DROP SINGLE FRONT AXLE	190	
402-013	MERITOR 16.5X6 Q+ CAST SPIDER HEAVY DUTY CAM FRONT BRAKES, DOUBLE ANCHOR, FABRICATED SHOES		
403-002	NON-ASBESTOS FRONT BRAKE LINING		
419-001	CAST IRON OUTBOARD FRONT BRAKE DRUMS		
427-001	FRONT BRAKE DUST SHIELDS	5	
409-006	FRONT OIL SEALS		
408-001	VENTED FRONT HUB CAPS WITH WINDOW, CENTER AND SIDE PLUGS - OIL		
416-022	STANDARD SPINDLE NUTS FOR ALL AXLES		

 The linked image c...

Prepared for:
KRIS PARKE
BAZETTA TOWNSHIP
3372 ST RT 5
CORTLAND, OH 44410
Phone: 330-219-4749

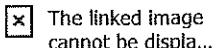

Prepared by:
Ron Knight
FYDA FREIGHTLINER
YOUNGSTOWN
5260 SEVENTY-SIX DR.
YOUNGSTOWN, OH 44515
Phone: 330-797-0224

Data Code	Description	Weight Front	Weight Rear
405-031	HALDEX AUTOMATIC FRONT SLACK ADJUSTERS WITH STAINLESS STEEL CLEVIS PINS		
406-001	STANDARD KING PIN BUSHINGS		
536-012	TRW TAS-85 POWER STEERING	40	
539-003	POWER STEERING PUMP		
534-015	2 QUART SEE THROUGH POWER STEERING RESERVOIR		
40T-002	CURRENT AVAILABLE SYNTHETIC 75W-90 FRONT AXLE LUBE		
Front Suspension			
620-026	16,000# TAPERLEAF FRONT SUSPENSION	200	
619-005	MAINTENANCE FREE RUBBER BUSHINGS - FRONT SUSPENSION		
62G-998	NO FRONT SUSPENSION OPTIONS		
410-001	FRONT SHOCK ABSORBERS		
Rear Axle and Equipment			
420-051	RS-23-160 23,000# R-SERIES SINGLE REAR AXLE		180
421-563	5.63 REAR AXLE RATIO		
424-001	IRON REAR AXLE CARRIER WITH STANDARD AXLE HOUSING		
386-073	MXL 17T MERITOR EXTENDED LUBE MAIN DRIVELINE WITH HALF ROUND YOKES		
452-001	DRIVER CONTROLLED TRACTION DIFFERENTIAL - SINGLE REAR AXLE		20
878-018	(1) DRIVER CONTROLLED DIFFERENTIAL LOCK REAR VALVE FOR SINGLE DRIVE AXLE		
87B-004	BLINKING LAMP WITH EACH MODE SWITCH, DIFFERENTIAL UNLOCK WITH IGNITION OFF, ACTIVE <5 MPH		
423-033	MERITOR 16.5X7 Q+ CAST SPIDER HEAVY DUTY CAM REAR BRAKES, DOUBLE ANCHOR, FABRICATED SHOES		
433-002	NON-ASBESTOS REAR BRAKE LINING		
434-011	BRAKE CAMS AND CHAMBERS ON FORWARD SIDE OF DRIVE AXLE(S)		
451-001	CAST IRON OUTBOARD REAR BRAKE DRUMS		
425-002	REAR BRAKE DUST SHIELDS		5
440-006	REAR OIL SEALS		
426-1B2	BENDIX EVERSURE LONGSTROKE 1-DRIVE AXLE SPRING PARKING CHAMBERS		
428-031	HALDEX AUTOMATIC REAR SLACK ADJUSTERS WITH STAINLESS STEEL CLEVIS PINS		

Prepared for:
KRIS PARKE
BAZETTA TOWNSHIP
3372 ST RT 5
CORTLAND, OH 44410
Phone: 330-219-4749

 The linked image cannot be displayed.

Prepared by:
Ron Knight
FYDA FREIGHTLINER
YOUNGSTOWN
5260 SEVENTY-SIX DR.
YOUNGSTOWN, OH 44515
Phone: 330-797-0224

Data Code	Description	Weight Front	Weight Rear
41T-002	CURRENT AVAILABLE SYNTHETIC 75W-90 REAR AXLE LUBE		
42T-001	STANDARD REAR AXLE BREATHER(S)		
Rear Suspension			
622-1DC	26,000# FLAT LEAF SPRING REAR SUSPENSION WITH HELPER AND RADIUS ROD		100
621-001	SPRING SUSPENSION - NO AXLE SPACERS		
431-001	STANDARD AXLE SEATS IN AXLE CLAMP GROUP		
623-005	FORE/AFT CONTROL RODS		
Brake System			
490-100	WABCO 4S/4M ABS		
871-001	REINFORCED NYLON, FABRIC BRAID AND WIRE BRAID CHASSIS AIR LINES		
904-001	FIBER BRAID PARKING BRAKE HOSE		
412-001	STANDARD BRAKE SYSTEM VALVES		
46D-002	STANDARD AIR SYSTEM PRESSURE PROTECTION SYSTEM		
413-002	STD U.S. FRONT BRAKE VALVE		
432-003	RELAY VALVE WITH 5-8 PSI CRACK PRESSURE, NO REAR PROPORTIONING VALVE		
480-086	BW AD-9SI BRAKE LINE AIR DRYER WITH HEATER		
479-003	AIR DRYER MOUNTED INBOARD ON LH RAIL		
460-007	ALUMINUM AIR BRAKE RESERVOIRS	-10	-15
607-001	CLEAR FRAME RAILS FROM BACK OF CAB TO FRONT REAR SUSPENSION BRACKET, BOTH RAILS OUTBOARD		
477-004	PULL CABLES ON ALL AIR RESERVOIR(S)		
Trailer Connections			
914-012	AIR CONNECTIONS TO END OF FRAME WITH GLAD HANDS FOR TRUCK WITH 38 INCHES ADDITIONAL LINE END OF FRAME		
296-010	PRIMARY CONNECTOR/RECEPTACLE WIRED FOR SEPARATE STOP/TURN, ABS CENTER PIN POWERED THROUGH IGNITION		
297-001	SAE J560 7-WAY PRIMARY TRAILER CABLE RECEPTACLE MOUNTED END OF FRAME		
335-004	UPGRADED CHASSIS MULTIPLEXING UNIT		
Wheelbase & Frame			
545-380	3800MM (150 INCH) WHEELBASE		

Prepared for:
KRIS PARKE
BAZETTA TOWNSHIP
3372 ST RT 5
CORTLAND, OH 44410
Phone: 330-219-4749

 The linked image cannot be displayed.

Prepared by:
Ron Knight
FYDA FREIGHTLINER
YOUNGSTOWN
5260 SEVENTY-SIX DR.
YOUNGSTOWN, OH 44515
Phone: 330-797-0224

Data Code	Description	Weight Front	Weight Rear
546-102	7/16X3-9/16X11-1/8 INCH STEEL FRAME (11.11MMX282.6MM/0.437X11.13 INCH) 120KSI	10	180
548-803	BODY COMPANY INSTALLED ADDITIONAL FRONT FRAME REINFORCEMENT FOR SNOW PLOW		
552-030	1600MM (63 INCH) REAR FRAME OVERHANG		
55W-006	FRAME OVERHANG RANGE: 61 INCH TO 70 INCH		
549-002	24 INCH INTEGRAL FRONT FRAME EXTENSION	140	-20
AC8-99D	CALC'D BACK OF CAB TO REAR SUSP C/L (CA): 84.06 in		
AE8-99D	CALCULATED EFFECTIVE BACK OF CAB TO REAR SUSPENSION C/L (CA): 81.06 in		
AE4-99D	CALC'D FRAME LENGTH - OVERALL: 277.75		
FSS-0LH	CALCULATED FRAME SPACE LH SIDE: 47.37 in		
FSS-0RH	CALCULATED FRAME SPACE RH SIDE: 112.01 in		
AM6-99D	CALC'D SPACE AVAILABLE FOR DECKPLATE: 78.45 in		
553-001	SQUARE END OF FRAME		
550-001	FRONT CLOSING CROSSMEMBER		
559-003	LIGHTWEIGHT HEAVY DUTY ALUMINUM ENGINE CROSSMEMBER	-12	
562-001	STANDARD MIDSHIP #1 CROSSMEMBER(S)		
572-001	STANDARD REARMOST CROSSMEMBER		
565-001	STANDARD SUSPENSION CROSSMEMBER		
Chassis Equipment			
556-997	OMIT FRONT BUMPER, CUSTOMER INSTALLED SPECIAL BUMPER, DOES NOT COMPLY WITH FMCSR 393.203	-110	
551-001	HUCK-SPIN ROUND COLLAR CHASSIS FASTENERS SUSPENSIONS ONLY		
Fuel Tanks			
204-215	50 GALLON/189 LITER SHORT RECTANGULAR ALUMINUM FUEL TANK - LH	-10	
218-005	RECTANGULAR FUEL TANK(S)		
215-005	PLAIN ALUMINUM/PAINTED STEEL FUEL/HYDRAULIC TANK(S) WITH PAINTED BANDS		
212-007	FUEL TANK(S) FORWARD		
664-001	PLAIN STEP FINISH		
205-001	FUEL TANK CAP(S)		

Prepared for:
KRIS PARKE
BAZETTA TOWNSHIP
3372 ST RT 5
CORTLAND, OH 44410
Phone: 330-219-4749

 The linked image cannot be displayed.

Prepared by:
Ron Knight
FYDA FREIGHTLINER
YOUNGSTOWN
5260 SEVENTY-SIX DR.
YOUNGSTOWN, OH 44515
Phone: 330-797-0224

Data Code	Description	Weight Front	Weight Rear
122-1H4	DETROIT FUEL/WATER SEPARATOR WITH WATER IN FUEL SENSOR AND 12 VOLT PREHEATER	-5	
216-020	EQUIFLO INBOARD FUEL SYSTEM		
202-016	HIGH TEMPERATURE REINFORCED NYLON FUEL LINE		
Tires			
093-1RJ	MICHELIN X WORKS Z 315/80R22.5 20 PLY RADIAL FRONT TIRES	100	
094-1UY	MICHELIN X MULTI D 11R22.5 16 PLY RADIAL REAR TIRES		60
510-1RK	MICHELIN X WORKS Z 11R22.5 16 PLY RADIAL SPARE TIRE		134
Hubs			
418-060	CONMET PRESET PLUS PREMIUM IRON FRONT HUBS		
450-060	CONMET PRESET PLUS PREMIUM IRON REAR HUBS		
Wheels			
502-433	ACCURIDE 29039 22.5X9.00 10-HUB PILOT 5.25 INSET 5-HAND STEEL DISC FRONT WHEELS	66	
505-428	ACCURIDE 28828 22.5X8.25 10-HUB PILOT 2-HAND HD STEEL DISC REAR WHEELS		52
511-428	ACCURIDE 28828 22.5X8.25 10-HUB PILOT 2-HAND HD STEEL DISC SPARE WHEEL		83
498-019	ALLIGATOR/V2B DUAL SEAL INFLATOR CAPS, FRONT AND REAR		
Cab Exterior			
829-1A5	108 INCH BBC FLAT ROOF ALUMINUM CONVENTIONAL CAB		
650-008	AIR CAB MOUNTING		
648-002	NONREMOVABLE BUGSCREEN MOUNTED BEHIND GRILLE		
667-037	SHORT FENDER WITH MUDFLAP		
754-017	BOLT-ON MOLDED FLEXIBLE FENDER EXTENSIONS	10	
678-018	LH AND RH EXTERIOR GRAB HANDLES WITH SINGLE RUBBER INSERT		
645-002	BRIGHT FINISH RADIATOR SHELL/HOOD BEZEL		
646-042	STATIONARY BLACK GRILLE WITH BRIGHT ACCENTS		
65X-003	CHROME HOOD MOUNTED AIR INTAKE GRILLE		
644-004	FIBERGLASS HOOD		

Prepared for:
 KRIS PARKE
 BAZETTA TOWNSHIP
 3372 ST RT 5
 CORTLAND, OH 44410
 Phone: 330-219-4749

 The linked image cannot be displayed.

Prepared by:
 Ron Knight
 FYDA FREIGHTLINER
 YOUNGSTOWN
 5260 SEVENTY-SIX DR.
 YOUNGSTOWN, OH 44515
 Phone: 330-797-0224

Data Code	Description	Weight Front	Weight Rear
690-002	TUNNEL/FIREWALL LINER		
727-1AF	SINGLE 14 INCH ROUND HADLEY AIR HORN UNDER LH DECK		
726-002	DUAL ELECTRIC HORNS		
728-001	SINGLE HORN SHIELD		
657-001	DOOR LOCKS AND IGNITION SWITCH KEYED THE SAME		
78G-004	KEY QUANTITY OF 4		
575-001	REAR LICENSE PLATE MOUNT END OF FRAME		
327-012	SWITCH, INDICATOR LIGHT AND WIRING FOR (2) CUSTOMER FURNISHED BEACONS		
312-067	HALOGEN COMPOSITE HEADLAMPS WITH BRIGHT BEZELS		
302-047	LED AERODYNAMIC MARKER LIGHTS		
311-025	HEADLIGHTS ON WITH WIPERS, WITH LOW BEAM DAYTIME RUNNING LIGHTS		
294-017	INTEGRAL STOP/TAIL/BACKUP LIGHTS WITH 7 EXTRA FEET OF WIRE MOUNTED AT END OF FRAME		
300-015	STANDARD FRONT TURN SIGNAL LAMPS		
744-1BC	DUAL WEST COAST BRIGHT FINISH HEATED MIRRORS WITH LH AND RH REMOTE		
797-001	DOOR MOUNTED MIRRORS		
796-001	102 INCH EQUIPMENT WIDTH		
743-204	LH AND RH 8 INCH BRIGHT FINISH CONVEX MIRRORS MOUNTED UNDER PRIMARY MIRRORS		
729-001	STANDARD SIDE/REAR REFLECTORS		
768-043	63X14 INCH TINTED REAR WINDOW		
661-004	TINTED DOOR GLASS LH AND RH WITH TINTED OPERATING WING WINDOWS		
654-027	RH AND LH ELECTRIC POWERED WINDOWS, PASSENGER SWITCHES ON DOOR(S)	4	
663-013	1-PIECE SOLAR GREEN GLASS WINDSHIELD		
659-007	8 LITER (2 GAL) WINDSHIELD WASHER RESERVOIR, CAB MOUNTED, WITHOUT FLUID LEVEL INDICATOR		

Cab Interior

707-1AK	OPAL GRAY VINYL INTERIOR		
706-026	MOLDED PLASTIC DOOR PANEL WITHOUT VINYL INSERT WITH ALUMINUM KICKPLATE LOWER DOOR		

 The linked image cannot be displayed.

Prepared for:
KRIS PARKE
BAZETTA TOWNSHIP
3372 ST RT 5
CORTLAND, OH 44410
Phone: 330-219-4749

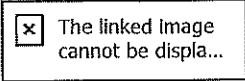

Prepared by:
Ron Knight
FYDA FREIGHTLINER
YOUNGSTOWN
5260 SEVENTY-SIX DR.
YOUNGSTOWN, OH 44515
Phone: 330-797-0224

Data Code	Description	Weight Front	Weight Rear
708-026	MOLDED PLASTIC DOOR PANEL WITHOUT VINYL INSERT WITH ALUMINUM KICKPLATE LOWER DOOR		
772-006	BLACK MATS WITH SINGLE INSULATION		
785-001	DASH MOUNTED ASH TRAYS AND LIGHTER		
691-008	FORWARD ROOF MOUNTED CONSOLE WITH UPPER STORAGE COMPARTMENTS WITHOUT NETTING		
742-007	(2) CUP HOLDERS LH AND RH DASH		
680-007	GRAY/CHARCOAL WING DASH		
860-004	SMART SWITCH EXPANSION MODULE		
720-002	2-1/2 LB. FIRE EXTINGUISHER	5	
* 700-001	HEATER AND DEFROSTER		
701-008	STANDARD HVAC DUCTING WITH SNOW SHIELD FOR FRESH AIR INTAKE		
* 703-006	MAIN HVAC CONTROLS WITHOUT RECIRCULATION SWITCH		
170-019	STANDARD HEATER PLUMBING WITH BALL SHUTOFF VALVES		
* 130-998	NO AIR CONDITIONER COMPRESSOR		
* 702-998	NO AIR CONDITIONER PLUMBING - MAIN		
739-034	PREMIUM INSULATION		
285-013	SOLID-STATE CIRCUIT PROTECTION AND FUSES		
280-007	12V NEGATIVE GROUND ELECTRICAL SYSTEM		
324-011	DOMED DOOR ACTIVATED LH AND RH, DUAL READING LIGHTS, FORWARD CAB ROOF		
655-005	LH AND RH ELECTRIC DOOR LOCKS		
284-023	(1) 12 VOLT POWER SUPPLY IN DASH		
722-002	TRIANGULAR REFLECTORS WITHOUT FLARES	10	
756-1D9	PREMIUM HIGH BACK AIR SUSPENSION DRIVER SEAT WITH 3 CHAMBER AIR LUMBAR, INTEGRATED CUSHION EXTENSION, FORWARD AND REAR CUSHION TILT, ADJUSTABLE SHOCK ABSORBER	70	
760-1DC	BASIC HIGH BACK NON SUSPENSION PASSENGER SEAT		
759-007	DUAL DRIVER SEAT ARMRESTS, NO PASSENGER SEAT ARMRESTS	4	
711-004	LH AND RH INTEGRAL DOOR PANEL ARMRESTS		
758-022	BLACK MORDURA CLOTH DRIVER SEAT COVER		
761-023	BLACK MORDURA CLOTH PASSENGER SEAT COVER		
763-101	BLACK SEAT BELTS		

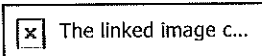

Prepared for:
 KRIS PARKE
 BAZETTA TOWNSHIP
 3372 ST RT 5
 CORTLAND, OH 44410
 Phone: 330-219-4749

 The linked image cannot be displayed.

Prepared by:
 Ron Knight
 FYDA FREIGHTLINER
 YOUNGSTOWN
 5260 SEVENTY-SIX DR.
 YOUNGSTOWN, OH 44515
 Phone: 330-797-0224

Data Code	Description	Weight Front	Weight Rear
532-002	ADJUSTABLE TILT AND TELESCOPING STEERING COLUMN	10	
540-015	4-SPOKE 18 INCH (450MM) STEERING WHEEL		
765-002	DRIVER AND PASSENGER INTERIOR SUN VISORS		

Instruments & Controls

732-003	WOODGRAIN DRIVER INSTRUMENT PANEL		
734-003	WOODGRAIN CENTER INSTRUMENT PANEL		
870-001	BLACK GAUGE BEZELS		
486-001	LOW AIR PRESSURE INDICATOR LIGHT AND AUDIBLE ALARM		
838-001	(1) SINGLE BRAKE APPLICATION AIR GAUGE		
840-002	2 INCH PRIMARY AND SECONDARY AIR PRESSURE GAUGES		
198-025	INTAKE MOUNTED AIR RESTRICTION INDICATOR WITHOUT GRADUATIONS		
721-001	97 DB BACKUP ALARM		3
149-017	ELECTRONIC CRUISE CONTROL WITH SWITCHES ON AUXILIARY GAUGE PANEL (B DASH PANEL)		
156-007	KEY OPERATED IGNITION SWITCH AND INTEGRAL START POSITION; 4 POSITION OFF/RUN/START/ACCESSORY		
811-042	ICU3S, 132X48 DISPLAY WITH DIAGNOSTICS, 28 LED WARNING LAMPS AND DATA LINKED		
160-038	HEAVY DUTY ONBOARD DIAGNOSTICS INTERFACE CONNECTOR LOCATED BELOW LH DASH		
844-001	2 INCH ELECTRIC FUEL GAUGE		
856-001	ELECTRICAL ENGINE COOLANT TEMPERATURE GAUGE		
864-001	2 INCH TRANSMISSION OIL TEMPERATURE GAUGE		
830-006	ENGINE AND TRIP HOUR METERS INTEGRAL WITHIN DRIVER DISPLAY AND HOBBS PTO OPERATION HOUR METER	2	
372-035	(1) DASH MOUNTED PTO SWITCH WITH INDICATOR LAMP	10	
852-002	ELECTRIC ENGINE OIL PRESSURE GAUGE		
679-001	OVERHEAD INSTRUMENT PANEL		
746-115	AM/FM/WB WORLD TUNER RADIO WITH BLUETOOTH AND USB AND AUXILIARY INPUTS, J1939	10	
747-001	DASH MOUNTED RADIO		

 The linked image cannot be displayed.

Prepared for:
 KRIS PARKE
 BAZETTA TOWNSHIP
 3372 ST RT 5
 CORTLAND, OH 44410
 Phone: 330-219-4749

 The linked image cannot be displa...

Prepared by:
 Ron Knight
 FYDA FREIGHTLINER
 YOUNGSTOWN
 5260 SEVENTY-SIX DR.
 YOUNGSTOWN, OH 44515
 Phone: 330-797-0224

Data Code	Description	Weight Front	Weight Rear
750-002	(2) RADIO SPEAKERS IN CAB		
753-001	AM/FM ANTENNA MOUNTED ON FORWARD LH ROOF		
748-006	POWER AND GROUND WIRING PROVISION OVERHEAD		
749-016	CB WIRING ONLY TO ROOF/OVERHEAD CONSOLE; NO MOUNTING PROVISION		
810-027	ELECTRONIC MPH SPEEDOMETER WITH SECONDARY KPH SCALE, WITHOUT ODOMETER		
817-001	STANDARD VEHICLE SPEED SENSOR		
812-001	ELECTRONIC 3000 RPM TACHOMETER		
162-002	IGNITION SWITCH CONTROLLED ENGINE STOP		
* 329-091	(6) IGN CONTROLLED EXTRA SWITCHES WITH IND LIGHTS WIRED TO POWER DIST BOX WITH RELAYS PROVIDING 20 AMPS PER CIRCUIT TO JUNCTION BLOCK AND 1 CIRCUIT AT 30 AMPS LOCATE (3) BLANK WIRED SWITCHES BEHIND DASH.		
81Y-001	PRE-TRIP LAMP INSPECTION, ALL OUTPUTS FLASH, WITH SMART SWITCH		
482-001	BW TRACTOR PROTECTION VALVE		
883-001	TRAILER HAND CONTROL BRAKE VALVE		
836-015	DIGITAL VOLTAGE DISPLAY INTEGRAL WITH DRIVER DISPLAY		
660-001	SINGLE ELECTRIC WINDSHIELD WIPER MOTOR WITH DELAY AND ARCTIC TYPE BLADES		
304-039	MARKER LIGHT SWITCH INTEGRAL WITH HEADLIGHT SWITCH AND DUAL CONNECTORS AND SWITCH FOR CUSTOMER FURNISHED SNOW PLOW LIGHTS, LOW BEAMS OFF WITH HIGH BEAMS		
882-004	TWO VALVE PARKING BRAKE SYSTEM WITH WARNING INDICATOR		
299-013	SELF CANCELING TURN SIGNAL SWITCH WITH DIMMER, WASHER/WIPER AND HAZARD IN HANDLE		
298-039	INTEGRAL ELECTRONIC TURN SIGNAL FLASHER WITH HAZARD LAMPS OVERRIDING STOP LAMPS		

Design

065-000 PAINT: ONE SOLID COLOR

Color

980-5F6 CAB COLOR A: L0006EY WHITE ELITE EY
 986-020 BLACK, HIGH SOLIDS POLYURETHANE CHASSIS PAINT

 The linked image c...

Prepared for:
 KRIS PARKE
 BAZETTA TOWNSHIP
 3372 ST RT 5
 CORTLAND, OH 44410
 Phone: 330-219-4749

 The linked image cannot be displa...

Prepared by:
 Ron Knight
 FYDA FREIGHTLINER
 YOUNGSTOWN
 5260 SEVENTY-SIX DR.
 YOUNGSTOWN, OH 44515
 Phone: 330-797-0224

Data Code	Description	Weight Front	Weight Rear
962-972	POWDER WHITE (N0006EA) FRONT WHEELS/RIMS (PKWHT21, TKWHT21, W, TW)		
966-972	POWDER WHITE (N0006EA) REAR WHEELS/RIMS (PKWHT21, TKWHT21, W, TW)		
* 96F-972	POWDER WHITE (N0006EA) SPARE WHEEL/RIM (PKWHT21, TKWHT21, W, TW)		
963-003	STANDARD E COAT/UNDERCOATING		

Certification / Compliance

996-001 U.S. FMVSS CERTIFICATION, EXCEPT SALES CABS AND GLIDER KITS

Raw Performance Data

AE8-99D CALCULATED EFFECTIVE BACK OF CAB TO REAR SUSPENSION C/L (CA) : 81.06 in
 AM6-99D CALC'D SPACE AVAILABLE FOR DECKPLATE : 78.45 in

Sales Programs

NO SALES PROGRAMS HAVE BEEN SELECTED

T O T A L V E H I C L E S U M M A R Y

Weight Summary

	Weight Front	Weight Rear	Total Weight
Factory Weight ⁺	7622 lbs	4555 lbs	12177 lbs
Total Weight ⁺	7622 lbs	4555 lbs	12177 lbs

Extended Warranty

WAG-010 TOWING: 1 YEAR/UNLIMITED MILES/KM EXTENDED TOWING COVERAGE \$550 CAP FEX APPLIES

Prepared for:
KRIS PARKE
BAZETTA TOWNSHIP
3372 ST RT 5
CORTLAND, OH 44410
Phone: 330-219-4749

 The linked image
cannot be displa...

Prepared by:
Ron Knight
FYDA FREIGHTLINER
YOUNGSTOWN
5260 SEVENTY-SIX DR.
YOUNGSTOWN, OH 44515
Phone: 330-797-0224

(+) Weights shown are estimates only.
If weight is critical, contact Customer Application Engineering.

(***) All cost increases for major components (Engines, Transmissions, Axles, Front and Rear Tires) and government mandated requirements, tariffs, and raw material surcharges will be passed through and added to factory invoices.

 The linked image c...

Prepared for:
 KRIS PARKE
 BAZETTA TOWNSHIP
 3372 ST RT 5
 CORTLAND, OH 44410
 Phone: 330-219-4749

 The linked image cannot be displayed.

Prepared by:
 Ron Knight
 FYDA FREIGHTLINER
 YOUNGSTOWN
 5260 SEVENTY-SIX DR.
 YOUNGSTOWN, OH 44515
 Phone: 330-797-0224

D I M E N S I O N S

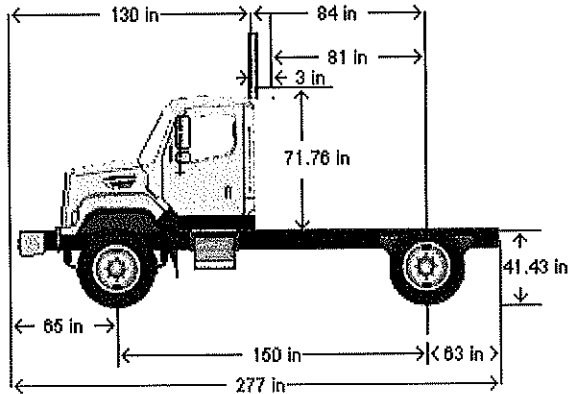

VEHICLE SPECIFICATIONS SUMMARY - DIMENSIONS

Wheelbase (545).....	3800MM (150 INCH) WHEELBASE
Rear Frame Overhang (552).....	1600MM (63 INCH) REAR FRAME OVERHANG
Fifth Wheel (578).....	NO FIFTH WHEEL
Mounting Location (577).....	NO FIFTH WHEEL LOCATION
Maximum Forward Position (in).....	0
Maximum Rearward Position (in).....	0
Amount of Slide Travel (in).....	0
Slide Increment (in).....	0
Desired Slide Position (in).....	0.0
Cab Size (829).....	108 INCH BBC FLAT ROOF ALUMINUM CONVENTIONAL CAB
Sleeper (682).....	NO SLEEPER BOX/SLEEPER CAB
Exhaust System (016).....	RH OUTBOARD UNDER STEP MOUNTED HORIZONTAL AFTERTREATMENT SYSTEM ASSEMBLY WITH RH B-PILLAR MOUNTED VERTICAL TAILPIPE

TABLE SUMMARY - DIMENSIONS

 The linked image c...

Prepared for:
 KRIS PARKE
 BAZETTA TOWNSHIP
 3372 ST RT 5
 CORTLAND, OH 44410
 Phone: 330-219-4749

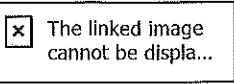

Prepared by:
 Ron Knight
 FYDA FREIGHTLINER
 YOUNGSTOWN
 5260 SEVENTY-SIX DR.
 YOUNGSTOWN, OH 44515
 Phone: 330-797-0224

Dimensions	Inches
Bumper to Back of Cab (BBC)	130.1
Bumper to Centerline of Front Axle (BA)	64.6
Min. Cab to Body Clearance (CB)	3.0
Back of Cab to Centerline of Rear Axle(s) (CA)	84.1
Effective Back of Cab to Centerline of Rear Axle(s) (Effective CA)	81.1
Back of Cab Protrusions (Exhaust/Intake) (CP)	0.0
Back of Cab Protrusions (Side Extenders/Trim Tab) (CP)	0.0
Back of Cab Protrusions (CNG Tank)	0.0
Back of Cab Clearance (CL)	3.0
Back of Cab to End of Frame	147.0
Cab Height (CH)	71.8
Wheelbase (WB)	149.6
Frame Overhang (OH)	63.0
Overall Frame Length	277.8
Overall Length (OAL)	277.1
Rear Axle Spacing	0.0
Unladen Frame Height at Centerline of Rear Axle	41.4

Performance calculations are estimates only. If performance calculations are critical, please contact Customer Application Engineering.

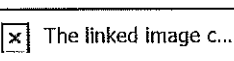



Bazetta Township Trustees

3372 State Route 5, N.E.-Cortland, Ohio 44410-1699
Office Phone: 330-637-8816 / Fax: 330-637-4588
www.bazettatwp.org



ABATEMENT OF WEEDS AND GRASS ONLY

505.87 (B) O.R.C.

RESOLUTION No. _____

BE IT RESOLVED, that legal notice of the Bazetta Township Board of Trustee's intention to remove and or abate the vegetation, noxious weeds and overgrown grass upon following premises, being given in accordance with Section 505.87 (B) O.R.C., and seven (7) days having passing, the Bazetta Township Board of Trustees hereby orders commencement of the abatement, control and removal of the vegetation, garbage, refuse or debris as provided in Section 505.87 (C) O.R.C.:

Parcel # 33-076303

aka :2369 Bianca Lane, Bazetta Township

Trumbull County, OHIO

AND BE IT FURTHER RESOLVED, that the Board of Trustees enter in to a contract with Cody's lawn Care, at a total cost of \$ (per Hourly service bid dated 2020 submitted by Cody's lawn Services, LLC}, to provide for the abatement, control and removal of the vegetation, garbage, refuse or debris.

Roll Call:



Bazetta Township Trustees

3372 State Route 5, N.E.-Cortland, Ohio 44410-1699
Office Phone: 330-637-8816 / Fax: 330-637-4588
www.bazettatwp.org



ABATEMENT OF WEEDS AND GRASS ONLY

505.87 (B) O.R.C.

RESOLUTION No. _____

BE IT RESOLVED, that legal notice of the Bazetta Township Board of Trustees intention to remove and or abate the vegetation, noxious weeds and overgrown grass upon following premises, being given in accordance with Section 505.87 (B) O.R.C., and seven (7) days having passing, the Bazetta Township Board of Trustees hereby orders commencement of the abatement, control and removal of the vegetation, garbage, refuse or debris as provided in Section 505.87 (C) O.R.C.:

Parcel # 33-066300

**aka : 4362 Hoagland Blackstub Rd,
Bazetta Township**

Trumbull County, OHIO

AND BE IT FURTHER RESOLVED, that the Board of Trustees enter in to a contract with Cody's lawn Care, at a total cost of \$ (per Hourly service bid dated 2020 submitted by Cody's lawn Services, LLC), to provide for the abatement, control and removal of the vegetation, garbage, refuse or debris.

Roll Call:



Bazetta Township Trustees

3372 State Route 5, N.E. - Cortland, Ohio 44410-1699
Office Phone: 330-637-8816 / Fax: 330-637-4588
www.bazettatwp.org



ABATEMENT OF WEEDS AND GRASS ONLY

505.87 (B) O.R.C.

RESOLUTION No. _____

BE IT RESOLVED, that legal notice of the Bazetta Township Board of Trustees' intention to remove and or abate the vegetation, noxious weeds and overgrown grass upon following premises, being given in accordance with Section 505.87 (B) O.R.C., and seven (7) days having passing, the Bazetta Township Board of Trustees hereby orders commencement of the abatement, control and removal of the vegetation, garbage, refuse or debris as provided in Section 505.87 (C) O.R.C.:

Parcel # 33-035726

**aka :3384 Durst Clagg Rd
, Bazetta Township
Trumbull County, OHIO**

AND BE IT FURTHER RESOLVED, that the Board of Trustees enter in to a contract with Cody's lawn Care, at a total cost of \$ (per Hourly service bid dated 2020 submitted by Cody's lawn Services, LLC), to provide for the abatement, control and removal of the vegetation, garbage, refuse or debris.

Roll Call:



Bazetta Township Trustees

3372 State Route 5, N.E.-Cortland, Ohio 44410-1699
Office Phone: 330-637-8816 / Fax: 330-637-4588
www.bazettatwp.org



ABATEMENT OF WEEDS AND GRASS ONLY

505.87 (B) O.R.C.

RESOLUTION No. _____

BE IT RESOLVED, that legal notice of the Bazetta Township Board of Trustee's intention to remove and or abate the vegetation, noxious weeds and overgrown grass upon following premises, being given in accordance with Section 505.87 {B} O.R.C., and seven {7} days having passing, the Bazetta Township Board of Trustees hereby orders commencement of the abatement, control and removal of the vegetation, garbage, refuse or debris as provided in Section 505.87 (C) O.R.C.:

Parcel # 31-084800

**aka :3223 Durst Clagg Rd,
Bazetta Township
Trumbull County, OHIO**

AND BE IT FURTHER RESOLVED, that the Board of Trustees enter in to a contract with Cody's lawn Care, at a total cost of \$ (per Hourly service bid dated 4/10/20 submitted by Cody's lawn Services, LLC), to provide for the abatement, control and removal of the vegetation, garbage, refuse or debris.